













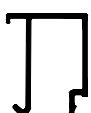



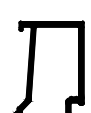







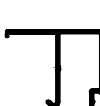
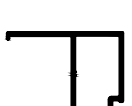
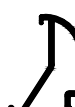































**Relación  
de  
Perfiles**





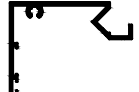
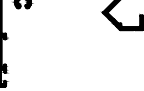

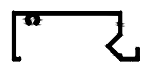

REF.	DISEÑO	DESCRIPCIÓN	PESO gr/m	SUPERF. TOTAL m <sup>2</sup> /m.l	MOMENTOS DE INERCIA Ix Iy cm <sup>4</sup>	PAG.
01000		Junquillo recto 5,5	202	0,124	0,47 0,21	C1
01001		Junquillo recto 8,5	246	0,149	0,60 0,21	C1
01002		Junquillo recto 11,5	233	0,145	0,70 0,26	C1
01003		Junquillo recto 14,5	239	0,148	0,69 0,32	C1
01004		Junquillo recto 18,5	253	0,154	0,77 0,47	C1
01005		Junquillo recto 21,5	259	0,160	0,79 0,49	C1
01006		Junquillo recto 24,5	269	0,166	0,82 0,56	C1
01007		Junquillo recto 27,5	278	0,172	0,86 0,66	C1
01008		Junquillo recto 30,4	291	0,178	0,90 0,81	C1
01009		Junquillo recto 17,2	250	0,148	0,68 0,37	C2
01010		Junquillo recto 22,7	273	0,159	0,77 0,53	C2
01012		Junquillo curvo 11,5 clip	219	0,136	0,57 0,19	C2

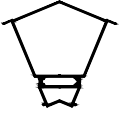
REF.	DISEÑO	DESCRIPCIÓN	PESO gr/m	SUPERF. TOTAL m <sup>2</sup> /m.l	MOMENTOS DE INERCIA Ix Iy cm <sup>4</sup>	PAG.
01013		Junquillo curvo 14,5 clip	225	0,139	0,61 0,28	C2
01014		Junquillo curvo 18,5 clip	239	0,146	0,68 0,35	C2
01015		Junquillo curvo 21,5 clip	245	0,152	0,72 0,39	C2
01016		Junquillo curvo 24,5 clip	254	0,158	0,77 0,45	C2
01020		Grapa junquillo	116	0,120*	0,04 0,12	C3
01027		Junquillo Recto 33,4	302	0,184	0,93 0,98	C1
01028		Junquillo Recto 36,4	313	0,190	0,96 1,19	C1
01032		Junquillo redondo 11,5 clip	220	0,136	0,56 0,22	C3
01033		Junquillo redondo 14,5 clip	227	0,140	0,61 0,28	C3
01034		Junquillo redondo 18,5 clip	240	0,147	0,68 0,39	C3
01035		Junquillo redondo 21,5 clip	246	0,153	0,71 0,44	C3
01036		Junquillo redondo 24,5 clip	256	0,159	0,76 0,50	C4

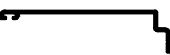
REF.	DISEÑO	DESCRIPCIÓN	PESO gr/m	SUPERF. TOTAL m <sup>2</sup> /m.l	MOMENTOS DE INERCIA Ix Iy cm <sup>4</sup>	PAG.
01052		Junquillo curvo 11,5 grapa	168	0,120*	0,31 0,10	C4
01053		Junquillo curvo 14,5 grapa	179	0,120*	0,37 0,13	C4
01054		Junquillo curvo 18,5 grapa	193	0,120*	0,43 0,19	C4
01055		Junquillo curvo 21,5 grapa	203	0,120*	0,47 0,25	C4
01056		Junquillo curvo 24,5 grapa	214	0,120*	0,50 0,35	C4
01062		Junquillo redondo 11,5 grapa	172	0,120*	0,32 0,13	C4
01063		Junquillo redondo 14,5 grapa	183	0,120*	0,37 0,15	C5
01064		Junquillo redondo 18,5 grapa	197	0,120*	0,43 0,22	C5
01065		Junquillo redondo 21,5 grapa	207	0,120*	0,47 0,29	C5
01066		Junquillo redondo 24,5 grapa	218	0,120*	0,51 0,40	C5
01077		Junquillo redondo 28,5 port.	309	0,186	0,80 0,93	C5
01087		Junquillo redondo 28,5 grapa	265	0,149	0,57 0,89	C5

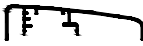
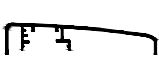
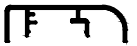

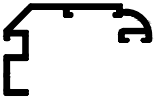

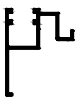

REF.	DISEÑO	DESCRIPCIÓN	PESO gr/m	SUPERF. TOTAL m <sup>2</sup> /m.l	MOMENTOS DE INERCIA Ix Iy cm <sup>4</sup>	PAG.
01102		Vierteaguas 50	297	0,150	0,08 4,01	C6
01103		Vierteaguas 75	399	0,200	0,18 10,77	C6
01104		Vierteaguas 85	440	0,221	0,24 14,69	C6
01105		Vierteaguas 95	541	0,241	0,35 21,63	C6
01106		Vierteaguas 105	587	0,261	0,44 27,88	C7
01108		Varilla de cierre	145	0,120*	0,0074 0,17	C10
01109		Remate inf. puertas	243	0,120*	0,64 0,29	C10
01116*		Vierteaguas 105 mm.	658	0,297	1,27 36,67	C7
01119		Vierteaguas 135 mm.	726	0,321	0,83 53,49	C7
01120		Vierteaguas 240 mm.	1614	0,646	13,44 351,97	C7
01131		Vierteaguas 60 mm.	352	0,176	0,17 5,82	C8
01132		Vierteaguas 70 mm.	407	0,199	0,23 8,93	C8

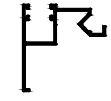
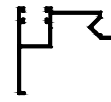
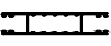
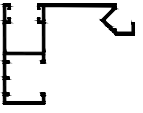
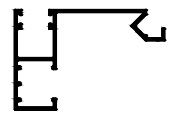
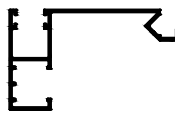
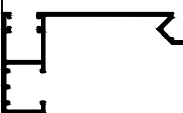
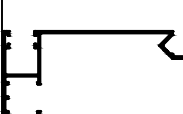
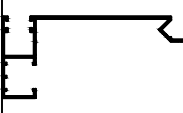
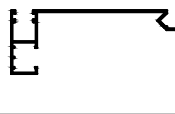
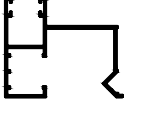
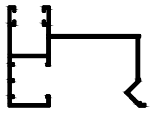

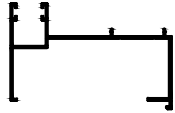
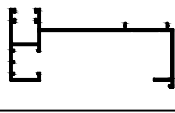
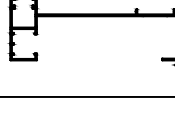

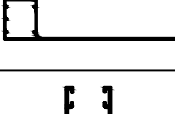

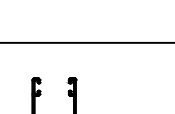
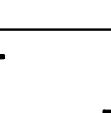

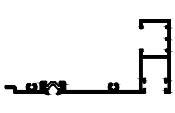
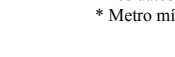

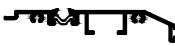
REF.	DISEÑO	DESCRIPCIÓN	PESO gr/m	SUPERF. TOTAL m <sup>2</sup> /m.l	MOMENTOS DE INERCIA Ix Iy cm <sup>4</sup>	PAG.
01133		Vierteaguas 80 mm.	458	0,227	0,30 12,98	C8
01143*		Vierteaguas 75 mm.	472	0,236	0,44 14,17	C8
01152		Vierteaguas 50 mm.	321	0.143	0,06 4,04	C9
01206*		Remate	238	0,134	0,42 0,42	C10
01207*		Abriga tabique	1095	0,496	7,16 98,09	C10
01208*		Suplemento remate	274	0,137	0,70 0,51	C10
01209		Bastidor portavidrio	522	0,207	2,13 1,24	C10
01210#		Suplemento exterior 44 mm.	560	0,279	2,77 7,12	C11
01211		Suplemento exterior 54 mm.	601	0,299	2,91 11,15	C11
01212*		Remate interior	200	0,120*	0,51 0,13	C10
01214		Suplemento exterior 60 mm.	550	0,288	1,86 12,07	C11
01223		Vierteaguas sup. 50 mm.	280	0,157	2,83 0,23	C9

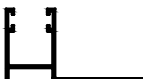

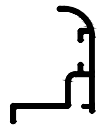



REF.	DISEÑO	DESCRIPCIÓN	PESO gr/m	SUPERF. TOTAL m <sup>2</sup> /m.l	MOMENTOS DE INERCIA Ix Iy cm <sup>4</sup>	PAG.
R1243		Esquinero 140 mm. - 135°	2986	1,272	274,68 179,82	C42
01301		Grapa solape	413	0,135	0,40 1,91	C12
01302		Tapajuntas 65 mm	317	0,184	0,19 6,28	C13
01303		Tapajuntas 50 mm	356	0,213	0,22 3,43	C12
01304		Tapajuntas 65 mm	419	0,251	0,25 6,51	C12
01305		Tapajuntas 80 mm	477	0,285	0,28 11,24	C12
01306		Tapajuntas recto	350	0,213	0,23 3,50	C12
01307		Tapajuntas 35 mm	212	0,124	0,16 1,40	C13
01308		Tapajuntas 40 mm	340	0,194	0,65 2,45	C13
01309		Complemento Union Guías	343	0,141	0,25 3,07	C12
01310		Complemento Guía	373	0,154	0,25 3,69	C12
01311		Guía Exterior 35 mm	627	0,328	5,08 4,84	C20



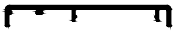
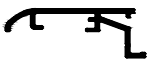
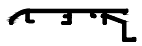



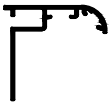
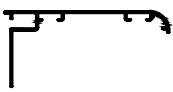
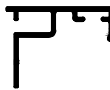
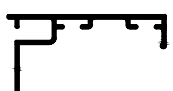
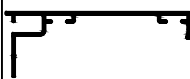

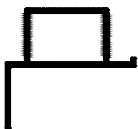
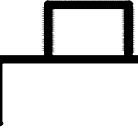
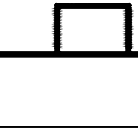
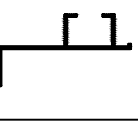
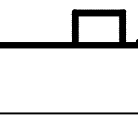
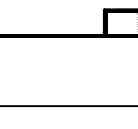
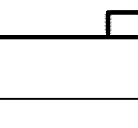
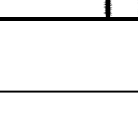
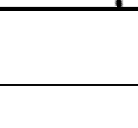
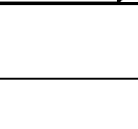
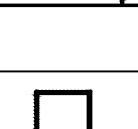
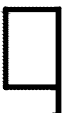

REF.	DISEÑO	DESCRIPCIÓN	PESO gr/m	SUPERF. TOTAL m <sup>2</sup> /m.l	MOMENTOS DE INERCIA Ix Iy cm <sup>4</sup>	PAG.
01312		Guía Exterior 45 mm	697	0,359	5,53 8,14	C20
01313		Guía Exterior 55 mm	738	0,379	5,87 12,55	C20
01320		Doble guía	1064	0,584	3,63 42,09	C20
01321		Guía Exterior 60 mm	855	0,442	9,59 15,16	C20
01322		Guía Exterior 70 mm	895	0,462	10,10 21,65	C21
01323		Guía Exterior 80 mm	936	0,482	10,58 29,65	C21
01324		Guía Exterior 90 mm	976	0,503	11,01 39,24	C21
01325		Guía Exterior 100 mm	1016	0,523	11,41 50,53	C21
01326*		Guía Exterior 110 mm	1080	0,542	11,96 64,61	C22
01328*		Guía Exterior 130 mm	1212	0,581	102,40 12,83	C22
01329		Guía Exterior 60 mm	898	0,461	8,17 15,91	C22
01330		Guía Exterior 70 mm	938	0,481	8,36 22,98	C22

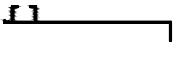

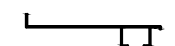
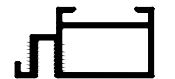
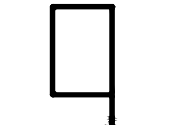

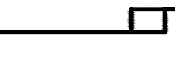
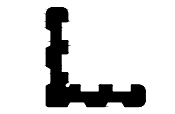





REF.	DISEÑO	DESCRIPCIÓN	PESO gr/m	SUPERF. TOTAL m <sup>2</sup> /m.l	MOMENTOS DE INERCIA Ix Iy cm <sup>4</sup>	PAG.
01331*		Guía Persiana 95 mm	1054	0,515	10,05 55,27	C23
01332*		Guía Persiana 120 mm	1260	0,621	11,55 101,53	C23
01333*		Guía Persiana 140 mm	1341	0,661	11,86 146,52	C24
01336*		Guía Persiana 180 mm	1597	0,722	12,28 267,12	C24
01337		Guía de pala 120 mm	991	0,520	11,25 43,83	C24
01338*		Guía simple	618	0,324	6,26 1,93	C25
01339*		Guía de pala 160 mm	1398	0,598	13,46 128,20	C25
01340		Guía de pala 73 mm	528	0,324	2,97 8,12	C25
R1341		Guía Persiana RT 95 mm	1203	0,558	11,72 59,01	C26
R1342		Guía Persiana RT 120 mm	1409	0,664	14,15 109,62	C26
R1343		Guía Persiana RT 140 mm	1491	0,704	14,68 158,65	C26
R1344		Guía Persiana RT 120 mm	1198	0,569	12,62 61,42	C27

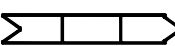

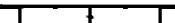
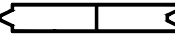



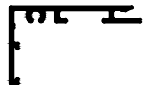

REF.	DISEÑO	DESCRIPCIÓN	PESO gr/m	SUPERF. TOTAL m <sup>2</sup> /m.l	MOMENTOS DE INERCIA Ix Iy cm <sup>4</sup>	PAG.
R1345		Vierteaguas RT 100 mm.	828	0,372	0,54 23,26	C9
R1346		Guia persiana RT 140 mm.	1279	0,609	13,15 93,96	C27
R1347		Vierteaguas RT 120 mm.	909	0,412	0,57 38,91	C9
01348*		Guia pala 62 mm.	517	0,276	2,15 5,69	C25
01352*		Guía Persiana 170 mm	1164	0,613	8,84 124,94	C27
01353		Tapajuntas registro 35 mm.	326	0,186	1,54 0,80	C12
01354*		Remate de registro	191	0,120*	0,14 0,49	C12
01358		Perfil union	508	0,242	0,27 7,84	C33
01359		Grapa para cofre	580	0,195	<del>0,59</del> 5,59	C33
01360		Grapa tapajuntas	500	0,165	0,25 5,79	C33
01361		Grapa tapajuntas plana	544	0,174	6,57	C12
01362		Tapajuntas plana 55 mm.	289	0,170	0,05 4,07	C13

REF.	DISEÑO	DESCRIPCIÓN	PESO gr/m	SUPERF. TOTAL m <sup>2</sup> /m.l	MOMENTOS DE INERCIA Ix Iy cm <sup>4</sup>	PAG.
01363		Tapajuntas plana 70 mm.	350	0,204	0,05 7,42	C13
01364		Tapajuntas registro 42 mm.	306	0,179	0,23 2,04	C14
01365*		Tapajuntas registro 60 mm.	409	0,234	0,26 5,42	C14
01366		Tapajuntas registro 90 mm.	533	0,294	0,29 16,68	C14
01367*		Remate de registro	264	0,162	0,34 0,6	C14
01368		Tapajuntas recto 50 mm.	289	0,17	0,05 3,06	C14
01369		Tapajuntas 45 mm.	376	0,218	1,76 0,82	C36
01370		Tapajuntas 90 mm.	495	0,259	1,86 3,21	C36
01371		Tapajuntas registro 40 mm.	536	0,279	1,89 5,11	C36
01372		Tapajuntas registro 60 mm.	495	0,259	1,86 3,21	C36
01373		Tapajuntas registro 85 mm.	536	0,279	1,89 5,11	C36
01401		Premarco Inferior	376	0,218	1,76 0,82	C36

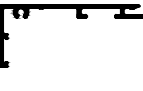

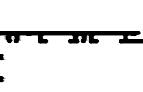
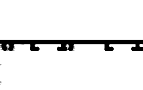

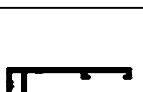

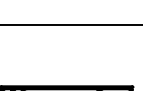
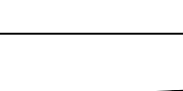
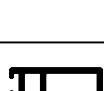
REF.	DISEÑO	DESCRIPCIÓN	PESO gr/m	SUPERF. TOTAL m <sup>2</sup> /m.l	MOMENTOS DE INERCIA Ix Iy cm <sup>4</sup>	PAG.
01402		Premarco de 40 mm	495	0,259	1,86 3,21	C36
01403		Premarco de 50 mm	536	0,279	1,89 5,11	C36
01404		Premarco de 60 mm	566	0,311	1,86 7,84	C36
01405		Premarco de 70 mm	565	0,291	1,50 11,33	C37
01406*		Premarco de 80 mm	658	0,339	1,95 16,57	C37
01413		Premarco de 110 mm	768	0,411	1,93 38,11	C37
01414		Premarco de 120 mm	809	0,431	1,94 48,01	C37
01415		Premarco de 130 mm	808	0,411	1,52 57,02	C38
01416		Premarco de 140 mm	890	0,471	1,95 72,32	C38
01418		Premarco de 160 mm	982	0,499	2,03 104,17	C38
01420		Premarco de 180 mm	1010	0,511	1,54 135,13	C39
01421*		Premarco inferior (variante)	294	0,199	1,35 0,62	C39



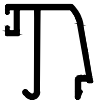

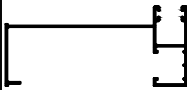
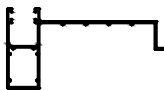
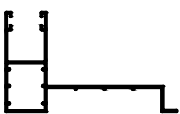
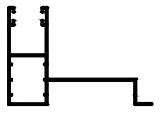
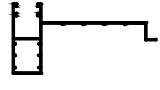
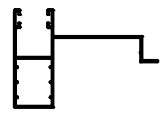

REF.	DISEÑO	DESCRIPCIÓN	PESO gr/m	SUPERF. TOTAL m <sup>2</sup> /m.l	MOMENTOS DE INERCIA Ix Iy cm <sup>4</sup>	PAG.
01422		Premarco 190 mm	1045	0,528	1,54 152,90	C40
01423		Premarco 50 mm	338	0,249	0,78 3,08	C40
01425		Premarco 50 mm	550	0,354	0,64 29,20	C41
01430*		Premarco de 36 mm	359	0,233	0,49 1,79	C41
01431		Premarco de 36 mm	262	0,192	1,21 0,54	C40
01434*		Premarco alu/mad 120 mm	813	0,416	2,29 47,77	C41
01436*		Premarco alu/mad 140 mm	894	0,456	2,32 72,10	C41
01481*		Escuadra presion	3201	0,307	45,35 45,35	C43
01482		Escuadra presion	1891	0,462	18,64 18,64	C43
01501		Hoja contraventana	482	0,266	0,90 4,30	C14
01502		Lama contraventana	702	0,459	0,33 24,57	C14
01503		Lama dos ondas	513	0,309	0,17 23,55	C15

REF.	DISEÑO	DESCRIPCIÓN	PESO gr/m	SUPERF. TOTAL m <sup>2</sup> /m.l	MOMENTOS DE INERCIA Ix Iy cm <sup>4</sup>	PAG.
01504		Lama tres ondas	554	0,335	0,16 30,94	C15
01505		Lama una onda	740	0,392	0,24 56,27	C15
01507		Lama ciega 140x25	1432	0,784	5,76 109,33	C15
01508*		Lama fija 110 mm.	662	0,404	1,90 26,96	C16
01509		Lama 200x26	2182	0,930	10,24 306,66	C17
01510		Lama ciega 150x25	1606	0,786	6,74 145,76	C18
01511		Lama 200x20	2092	0,942	5,56 285,41	C18
01512		Lama 200x20	1868	0,960	5,02 259,82	C19
01513		Lama 100x20	877	0,534	2,26 35,53	C17
01516		Lama ciega 100x20	899	0,536	2,29 27,63	C14
01518#		Lama fija 110 mm.	675	0,411	2,01 36,02	C16
01520		Lama 160 mm	1485	0,812	3,88 106,80	C19

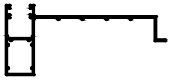
REF.	DISEÑO	DESCRIPCIÓN	PESO gr/m	SUPERF. TOTAL m <sup>2</sup> /m.l	MOMENTOS DE INERCIA Ix Iy cm <sup>4</sup>	PAG.
01701		Tape 40 mm	440	0,231	1,03 4,37	C45
01702		Tape 50 mm.	478	0,251	1,07 7,11	C45
01703		Tape 60 mm.	516	0,191	1,10 10,75	C45
01704		Tape 70 mm.	597	0,310	1,13 15,43	C45
01705		Tape 80 mm.	687	0,347	1,17 21,43	C45
01707		Tape 100 mm.	763	0,387	1,21 36,09	C46
01711		Solape Tape 30 mm.	193	0,108	0,06 0,62	C46
01712		Solape Tape 40 mm.	228	0,128	0,07 1,39	C46
01713		Solape Tape 50 mm.	263	0,148	0,07 2,57	C46
01714		Solape Tape 60 mm.	298	0,168	0,07 4,25	C46
01720		Vierteaguas 160 mm.	1185	0,539	1,04 77,02	C47
11006		Junquillo recto 24,5	304	0,188	0,85 0,73	C2

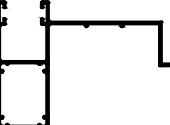

REF.	DISEÑO	DESCRIPCIÓN	PESO gr/m	SUPERF. TOTAL m <sup>2</sup> /m.l	MOMENTOS DE INERCIA Ix Iy cm <sup>4</sup>	PAG.
11016		Junquillo curvo 24,5 clip	290	0,179	0,80 0,60	C3
11056		Junquillo curvo 24,5 grapa	245	0,139	0,51 0,54	C4
IA077		Guía simple	482	0,334	4,97 1,50	C28
IA078		Lama terminal 44	271	0,271	2,09 0,08	C34
IA079		Guía de pala 120	949	0,528	10,25 44,27	C28
IA128		Guía persiana 120	958	0,588	9,10 78,50	C29
IA320		Guía persiana 106	974	0,542	8,33 41,92	C29
IA321		Guía persiana 90	829	0,505	6,72 23,38	C29
IA322		Guía persiana 76	698	0,457	5,97 13,10	C30
IA323		Guía persiana 108	897	0,540	6,81 37,99	C30
IA324		Guía persiana 76	698	0,462	5,46 13,11	C30
IA325		Eje mosquitera	288	0,137	0,38 0,42	C35

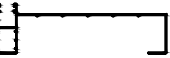
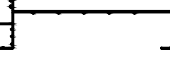
REF.	DISEÑO	DESCRIPCIÓN	PESO gr/m	SUPERF. TOTAL m <sup>2</sup> /m.l	MOMENTOS DE INERCIA Ix Iy cm <sup>4</sup>	PAG.
IA326		Guía persiana 121	1033	0,572	8,63 59,57	C31
IA327		Eje mosquitera	301	0,174	0,69 0,71	C35
IA328		Terminal persiana 44	305	0,225	0,09	C34
IA329		Terminal persiana 44	291	0,217	2,31 0,09	C34
IA330		Guía persiana 76	736	0,479	6,88 14,60	C31
IA331		Terminal	330	0,198	0,13 1,94	C33
IB467		Guía de pala 160	1148	0,604	11,39 104,67	C28
IB468		Guía persiana 180	1381	0,770	12,71 230,34	C31
IB469		Guía persiana 198	1510	0,802	11,95 293,52	C32

**Accesorios**

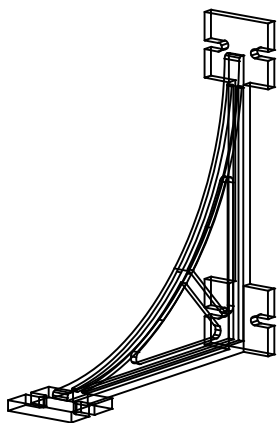

Cartabon premarco  
REF 2500001000

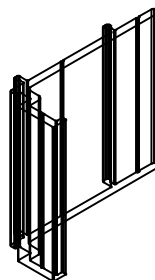

Grapa poliamida P1361  
REF 2508103000

Para perfiles: 01361  
01362  
01363

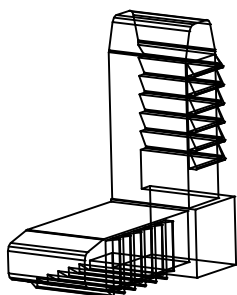

Escuadra premarco de 24,6 mm  
REF 2501001000



Grapa poliamida  
REF 2508104000

Para perfiles: 01303  
01304  
01305  
01306

**Perfiles**

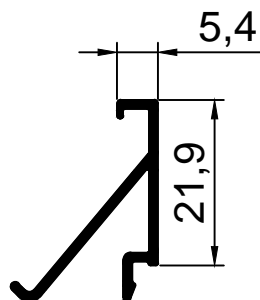

ALAS 01000

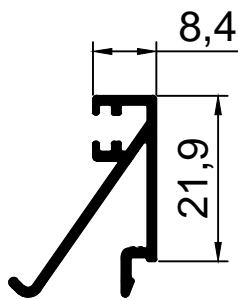

ALAS 01001

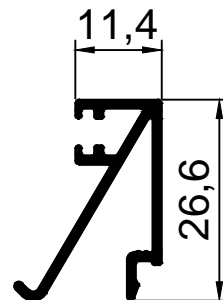

ALAS 01002

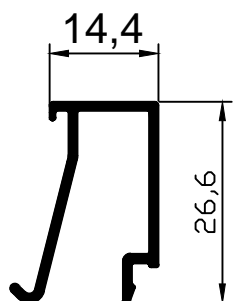

ALAS 01003

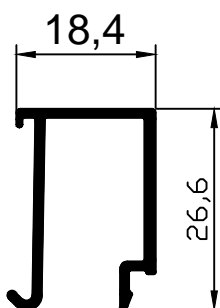

ALAS 01004

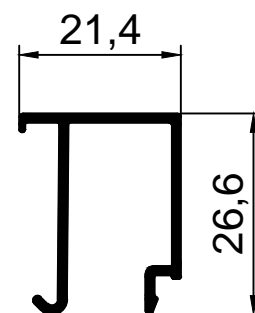

ALAS 01005

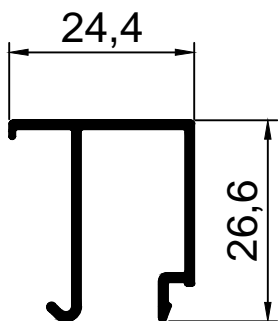

ALAS 01006

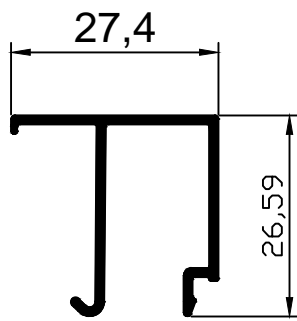

ALAS 01007

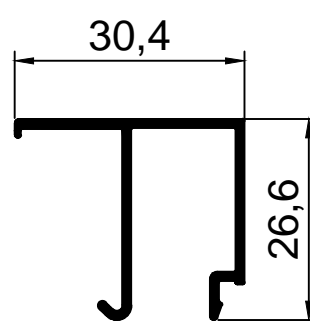

ALAS 01008

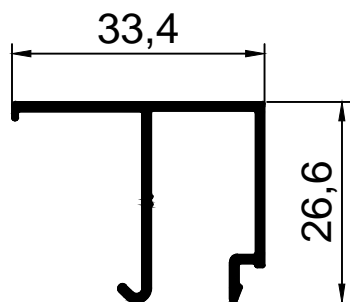

ALAS 01027

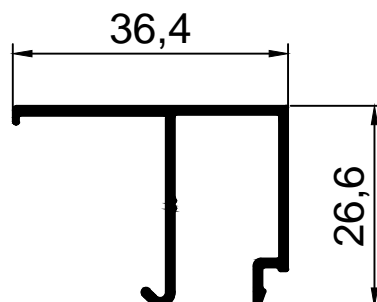

ALAS 01028

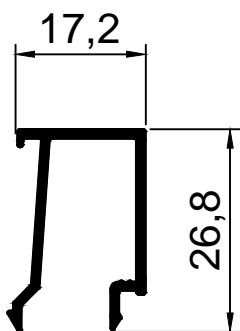

ALAS 01009

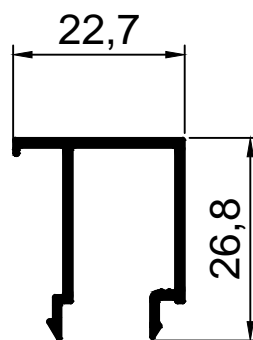

ALAS 01010

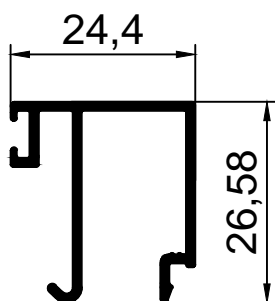

ALAS 11006

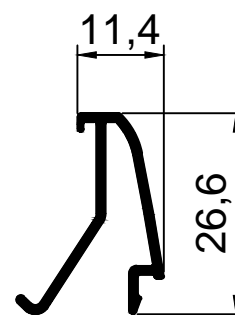

ALAS 01012

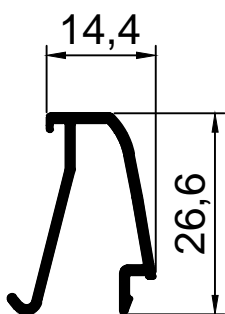

ALAS 01013

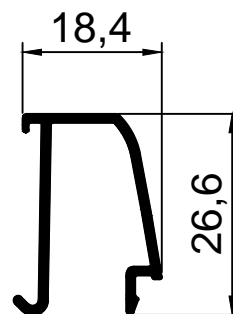

ALAS 01014

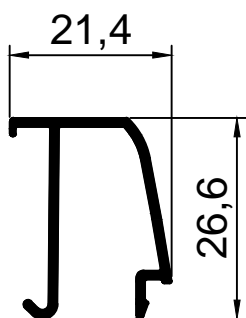

ALAS 01015

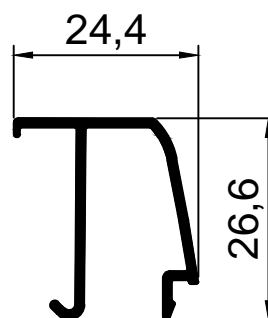

ALAS 01016

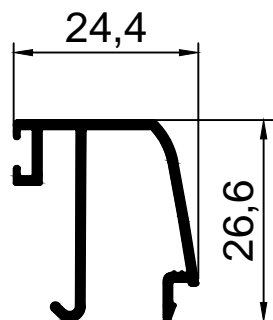

ALAS 11016

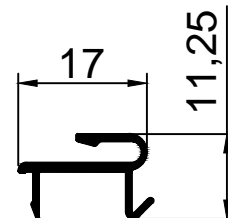

ALAS 01020

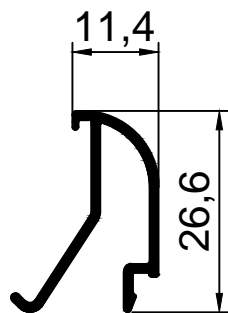

ALAS 01032

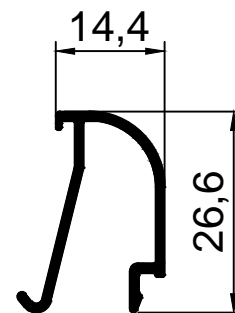

ALAS 01033

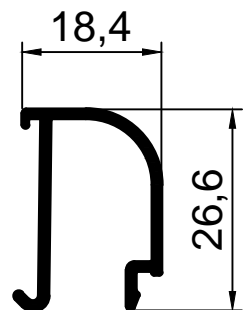

ALAS 01034

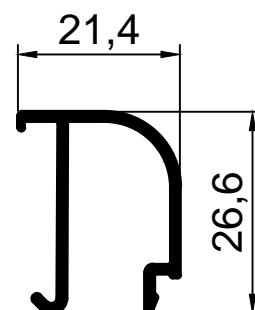

ALAS 01035



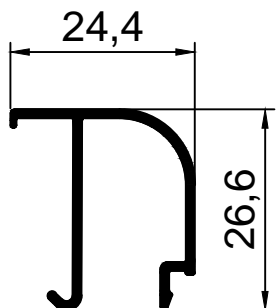

ALAS 01036

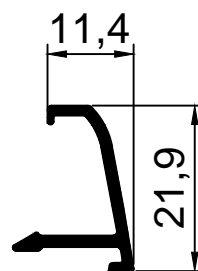

ALAS 01052

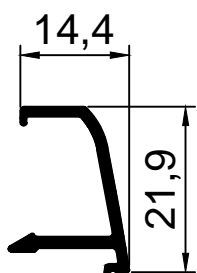

ALAS 01053

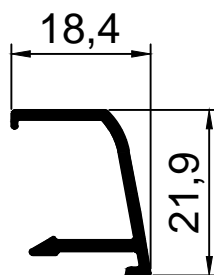

ALAS 01054

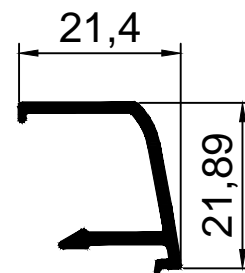

ALAS 01055

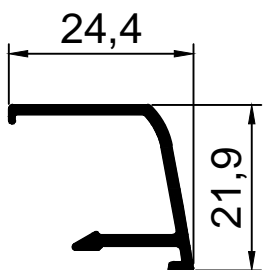

ALAS 01056

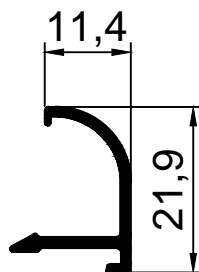

ALAS 01062

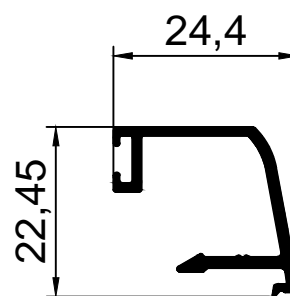

ALAS 11056

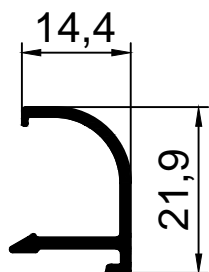

ALAS 01063

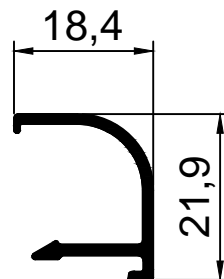

ALAS 01064

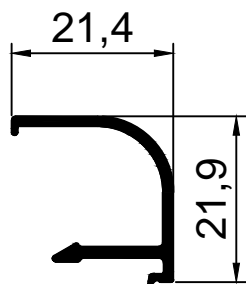

ALAS 01065

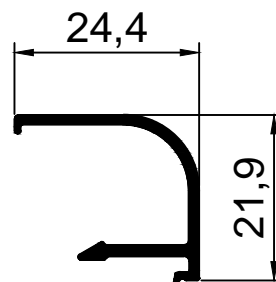

ALAS 01066

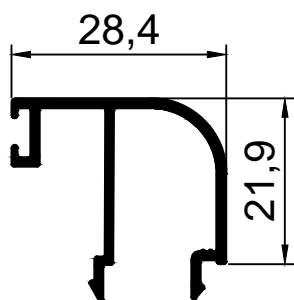

ALAS 01077

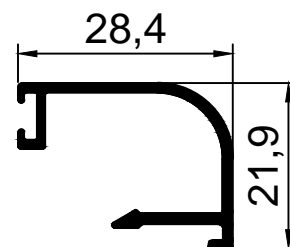

ALAS 01087

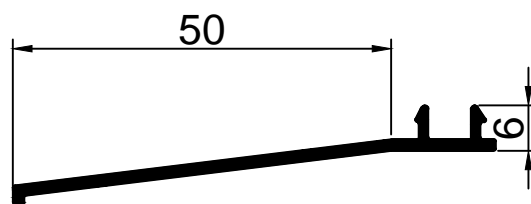

ALAS 01102

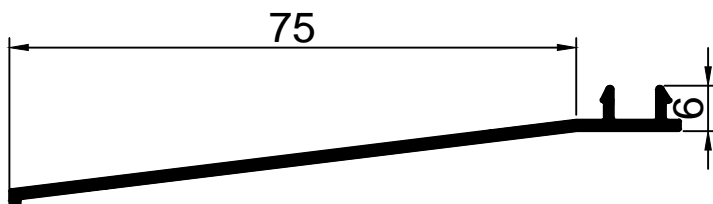

ALAS 01103

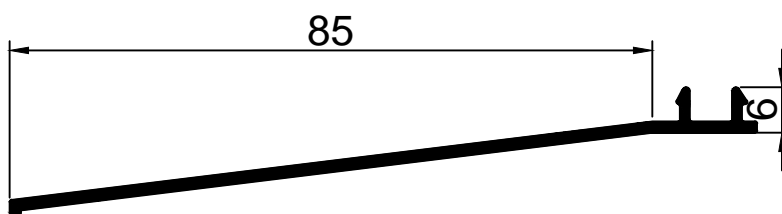

ALAS 01104

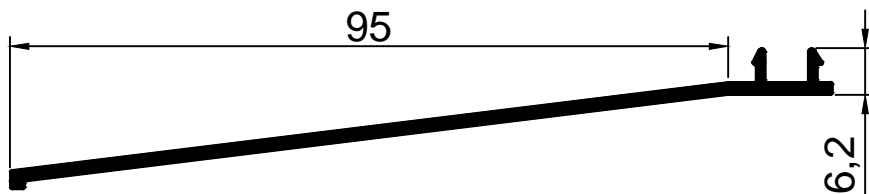

ALAS 01105

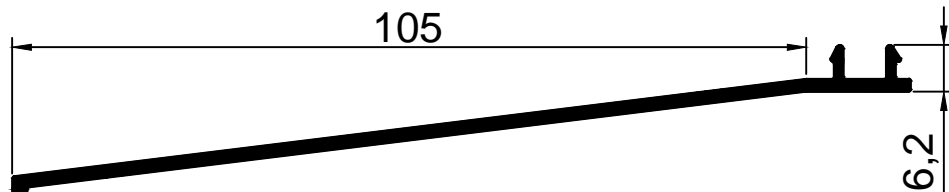

ALAS 01106

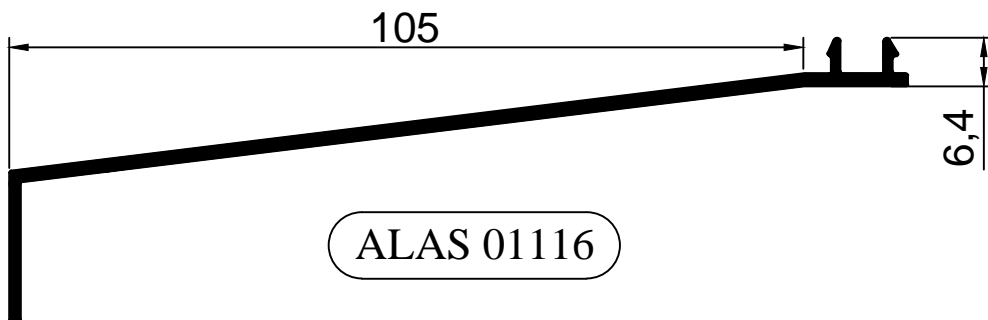

ALAS 01116

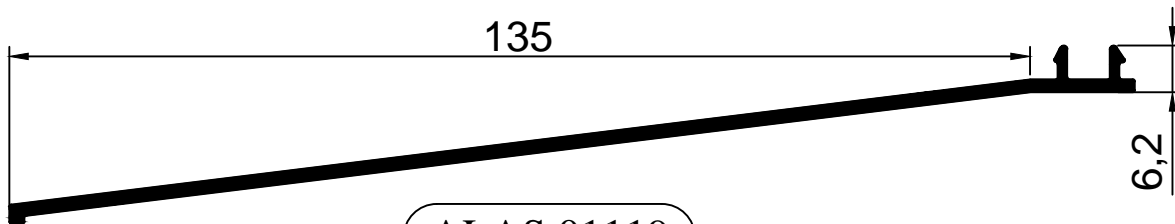

ALAS 01119

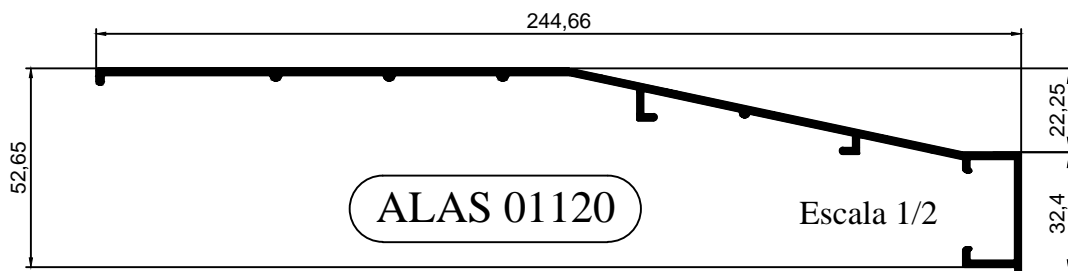

ALAS 01120

Escala 1/2

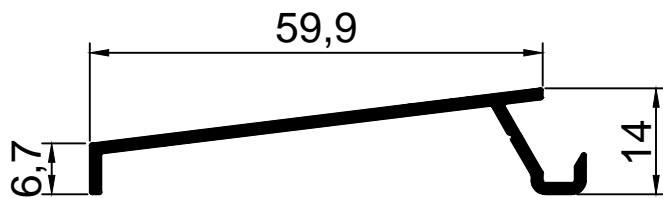

ALAS 01131

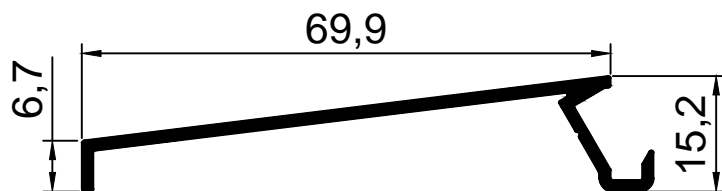

ALAS 01132

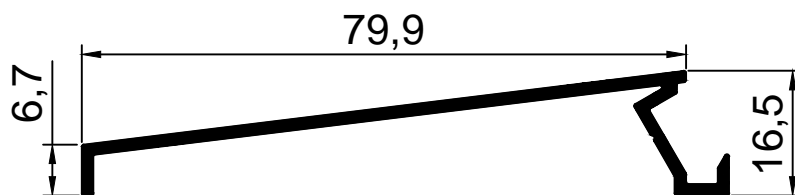

ALAS 01133

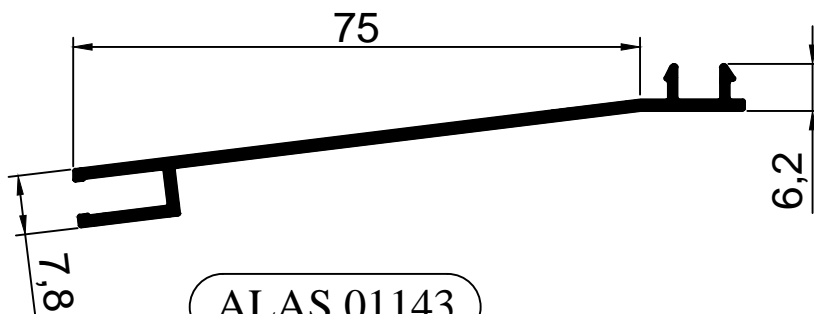

ALAS 01143

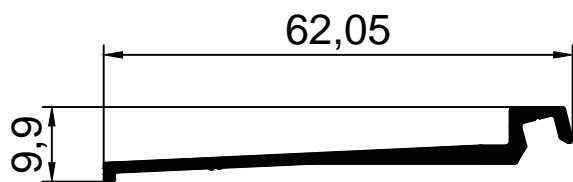

ALAS 01152

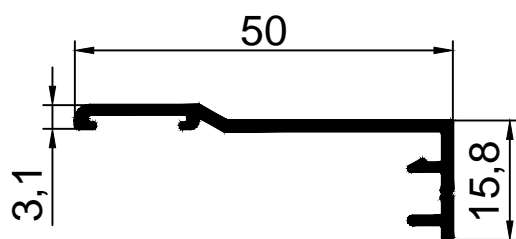

ALAS 01223

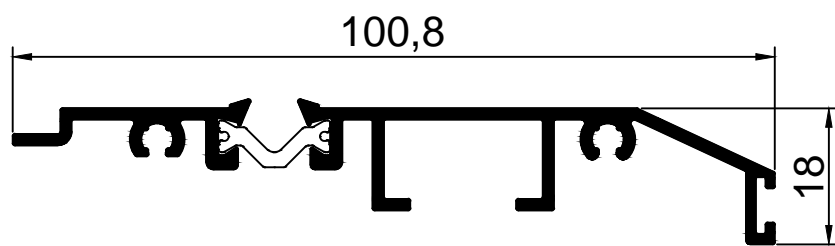

ALAS R1345

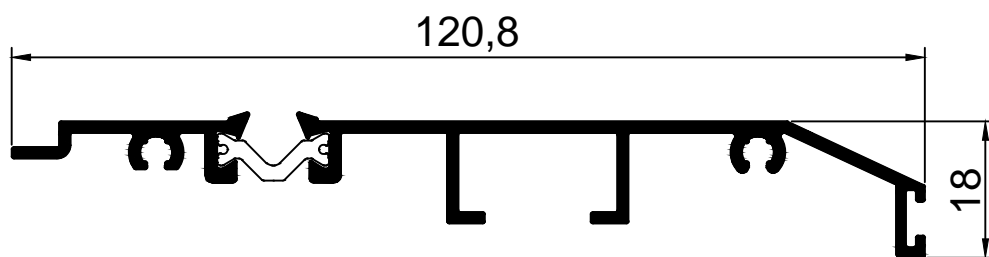

ALAS R1347

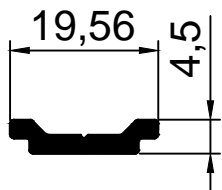

ALAS 01108

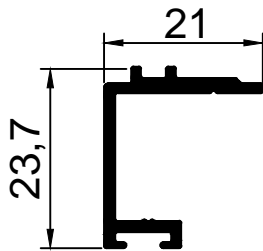

ALAS 01109

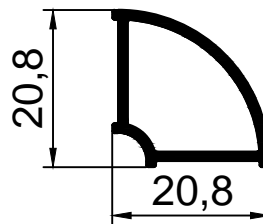

ALAS 01206

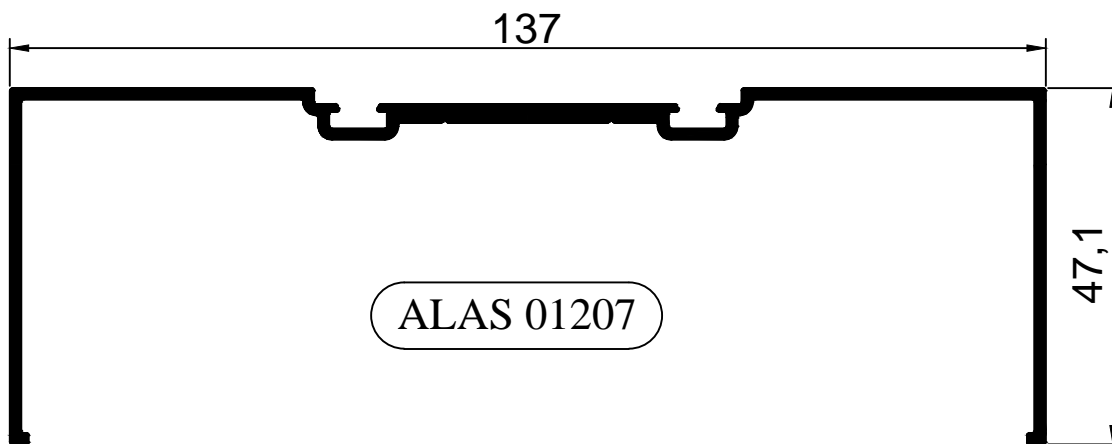

ALAS 01207

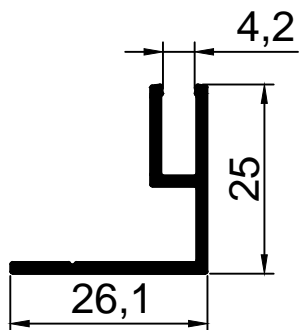

ALAS 01208

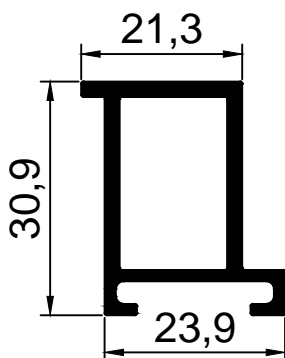

ALAS 01209

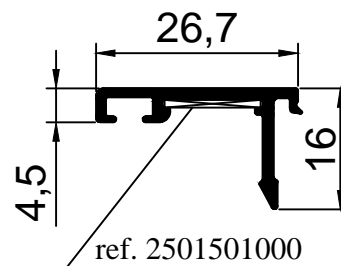

ALAS 01212

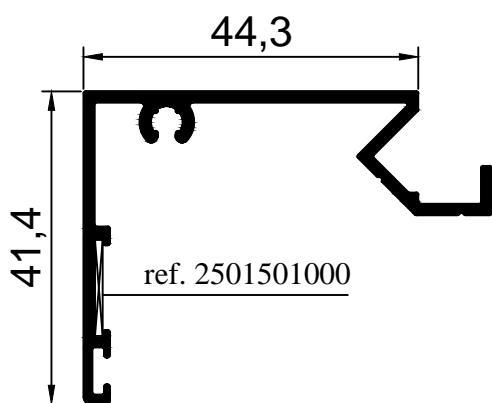

ALAS 01210

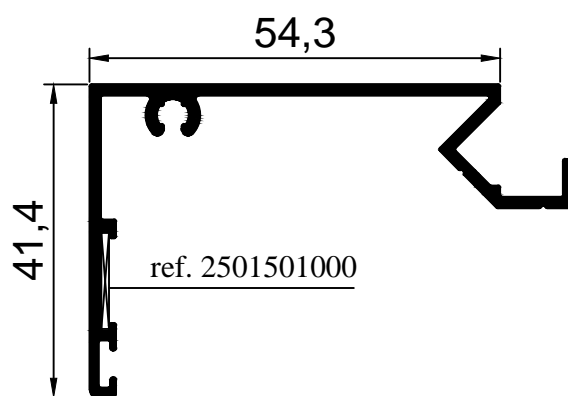

ALAS 01211

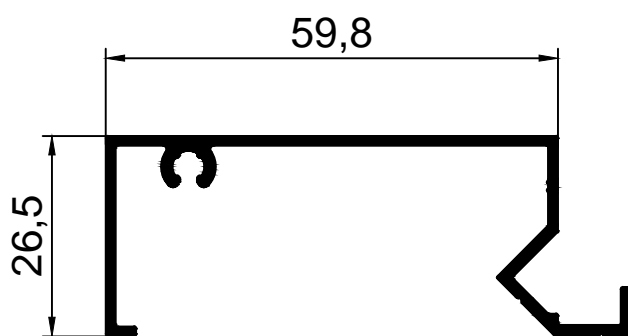

ALAS 01214



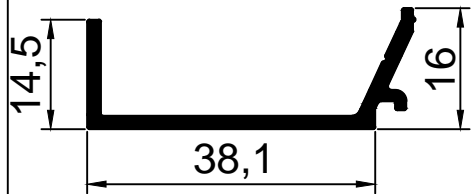

ALAS 01309

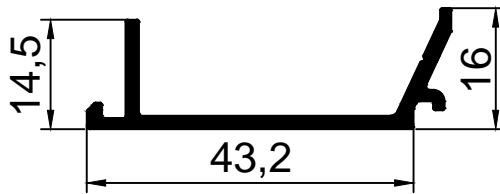

ALAS 01310

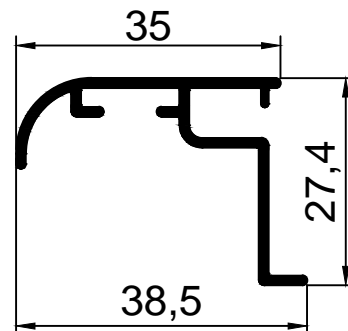

ALAS 01353

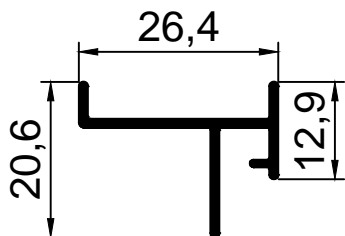

ALAS 01354

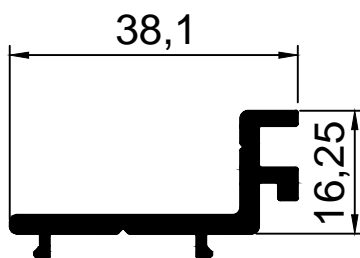

ALAS 01301

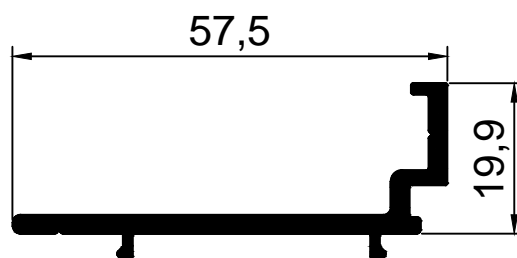

ALAS 01361

Escuadra ref. 2501504000  
(Alternativa ref. 2501401000)

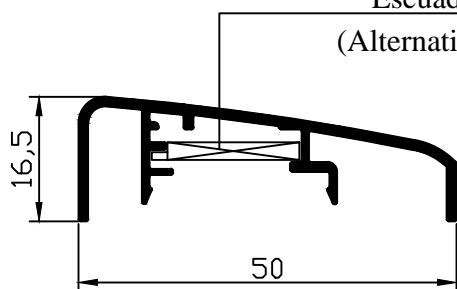

ALAS 01303

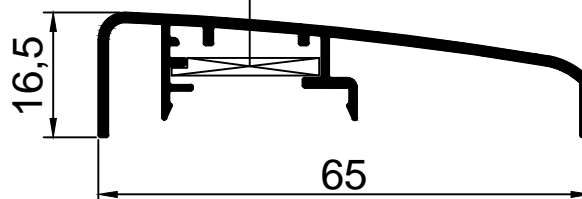

ALAS 01304

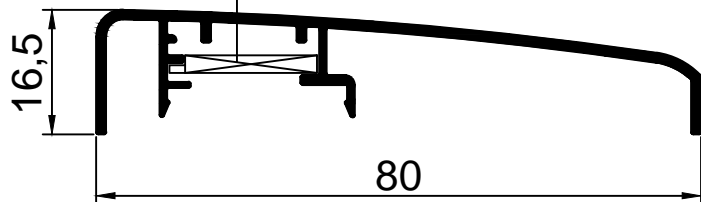

ALAS 01305

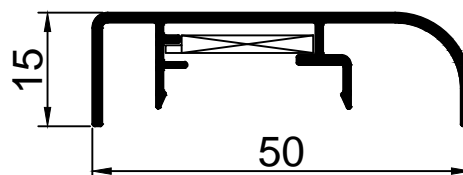

ALAS 01306

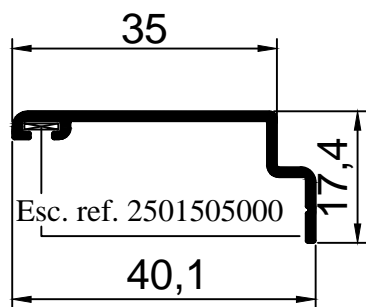

ALAS 01307

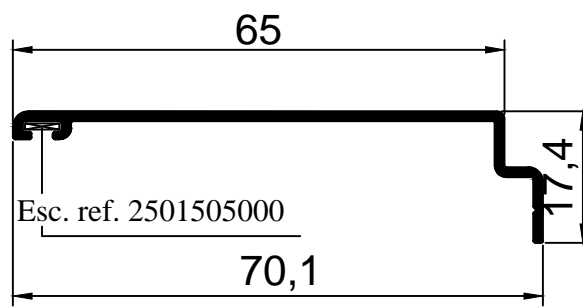

ALAS 01302

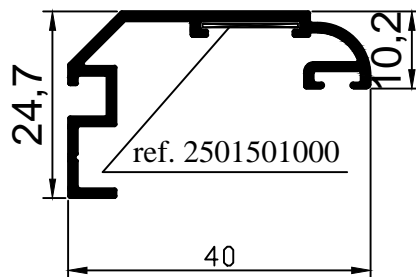

ALAS 01308

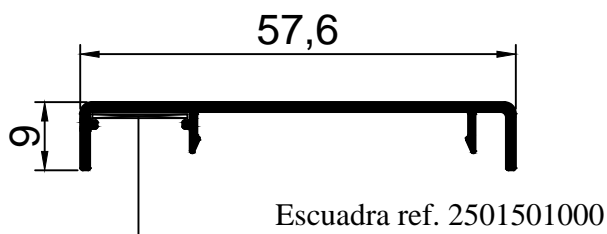

ALAS 01362

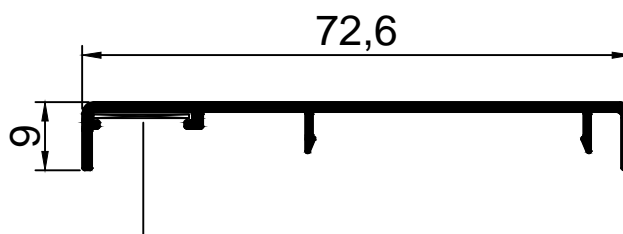

ALAS 01363

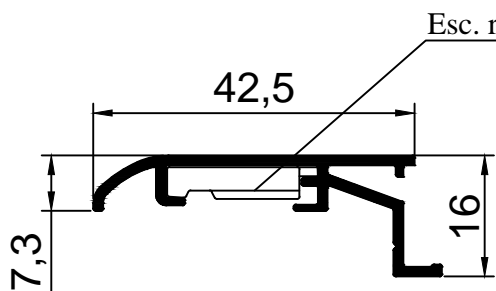

ALAS 01364

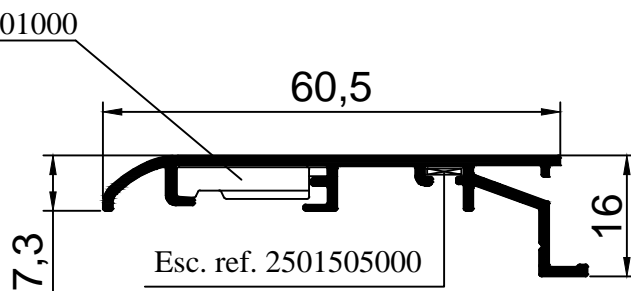

ALAS 01365

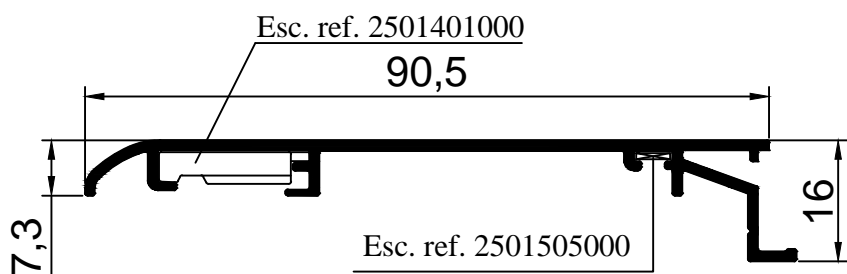

ALAS 01366

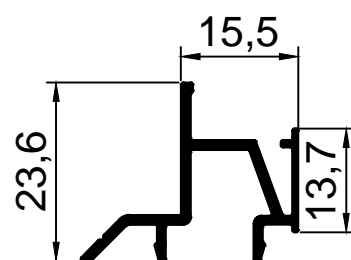

ALAS 01367

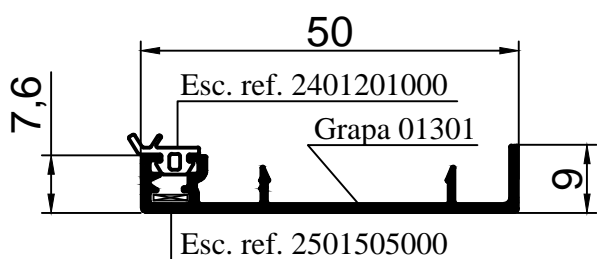

ALAS 01368

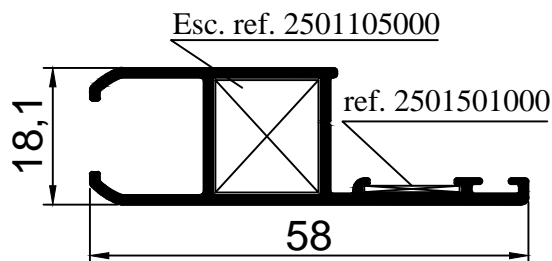

ALAS 01501

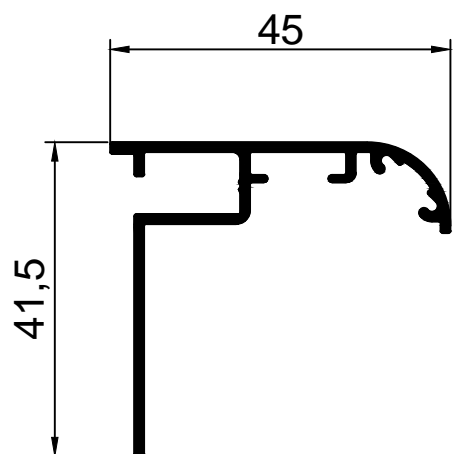

ALAS 01369

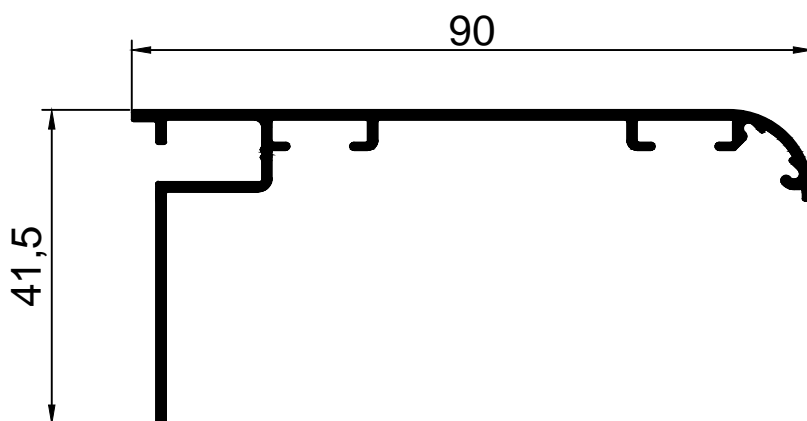

ALAS 01370

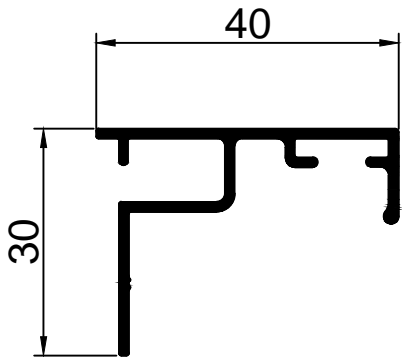

ALAS 01371

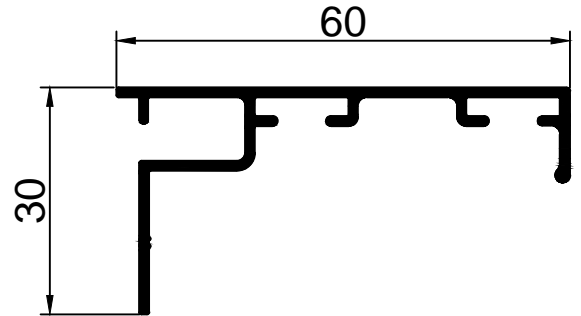

ALAS 01372

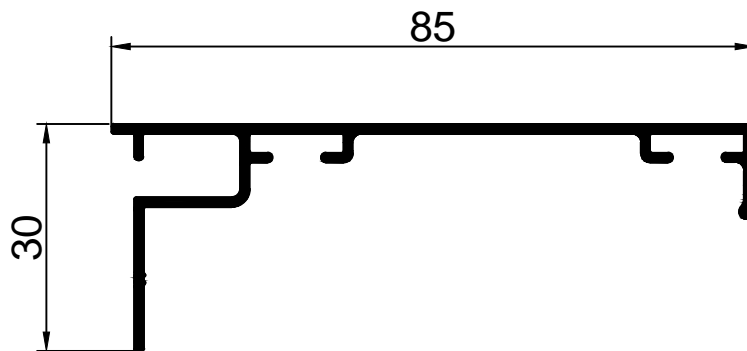

ALAS 01373

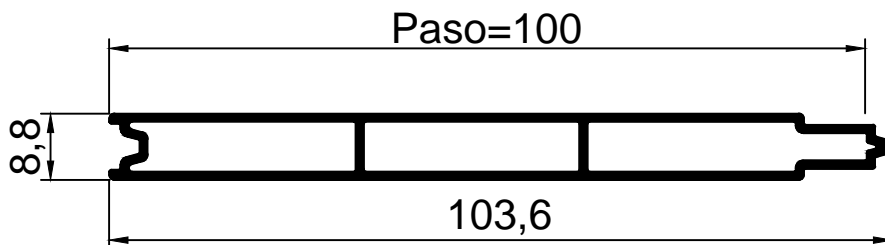

ALAS 01502

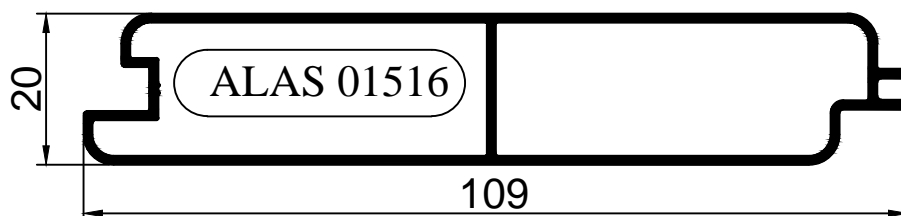

ALAS 01516

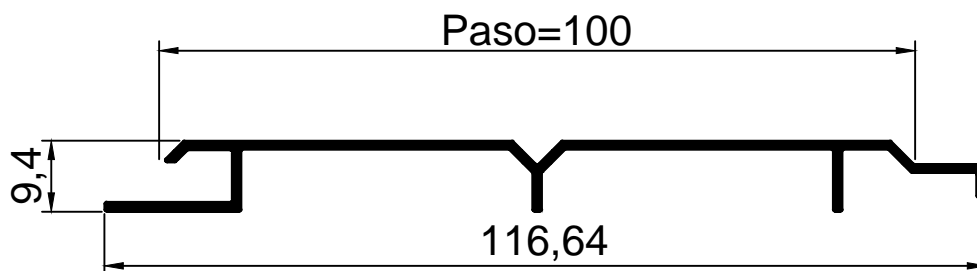

ALAS 01503

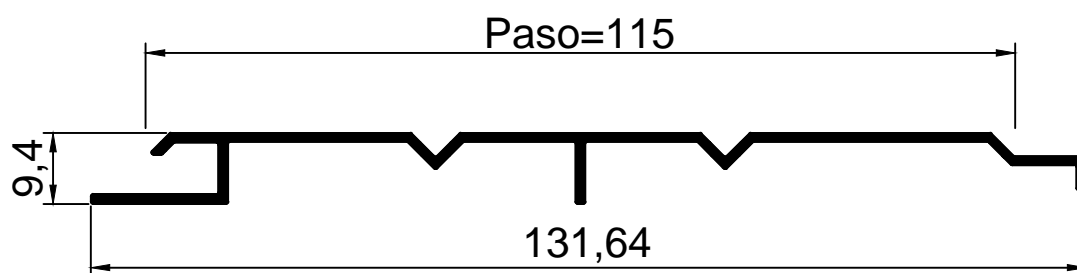

ALAS 01504

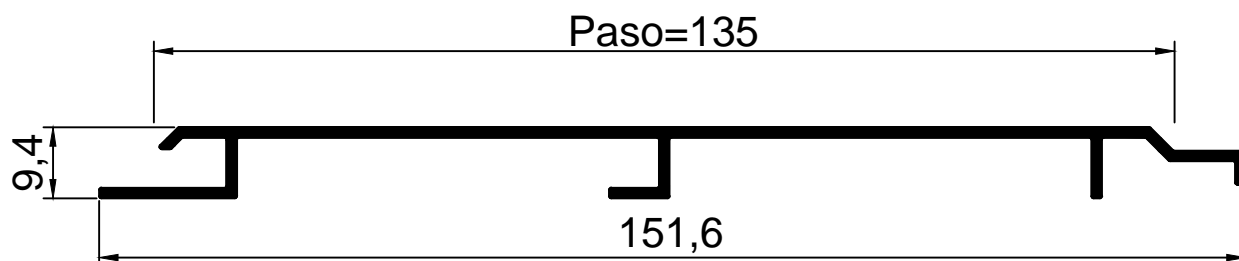

ALAS 01505

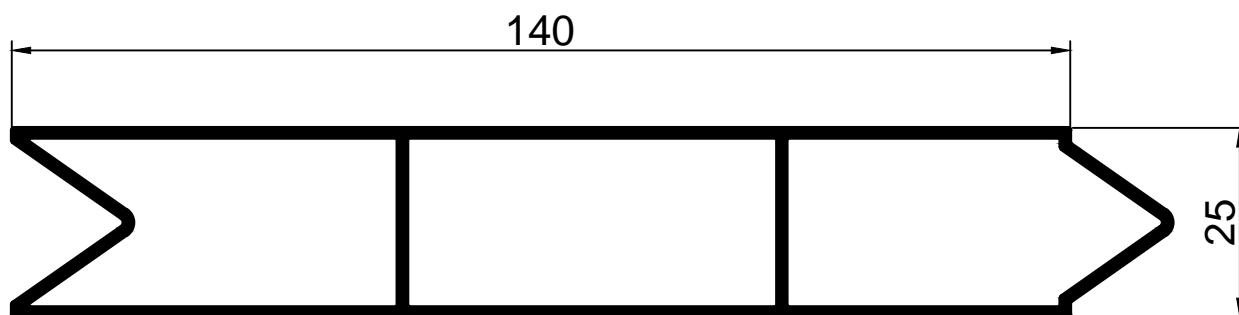

ALAS 01507

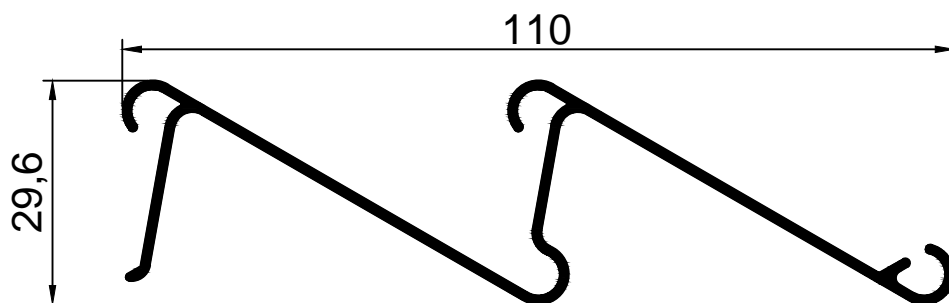

ALAS 01508

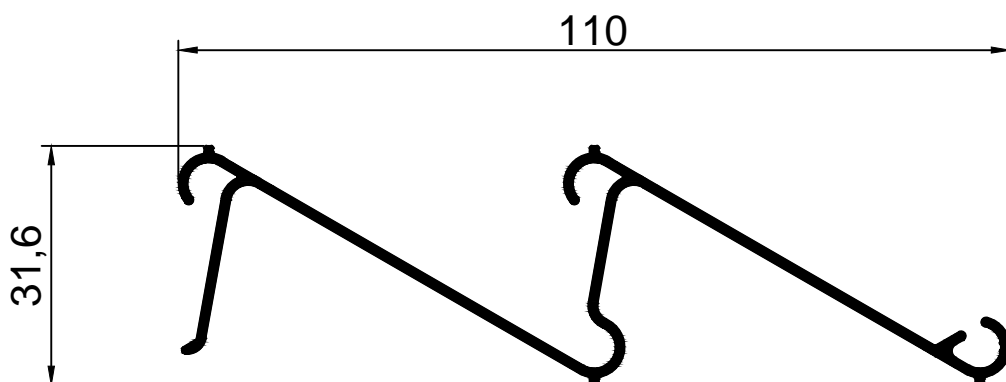

ALAS 01518

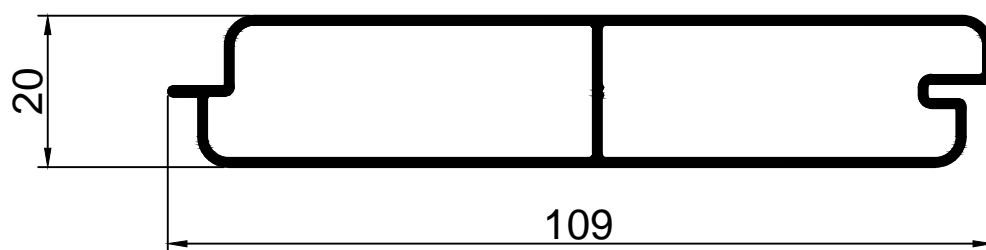

ALAS 01516

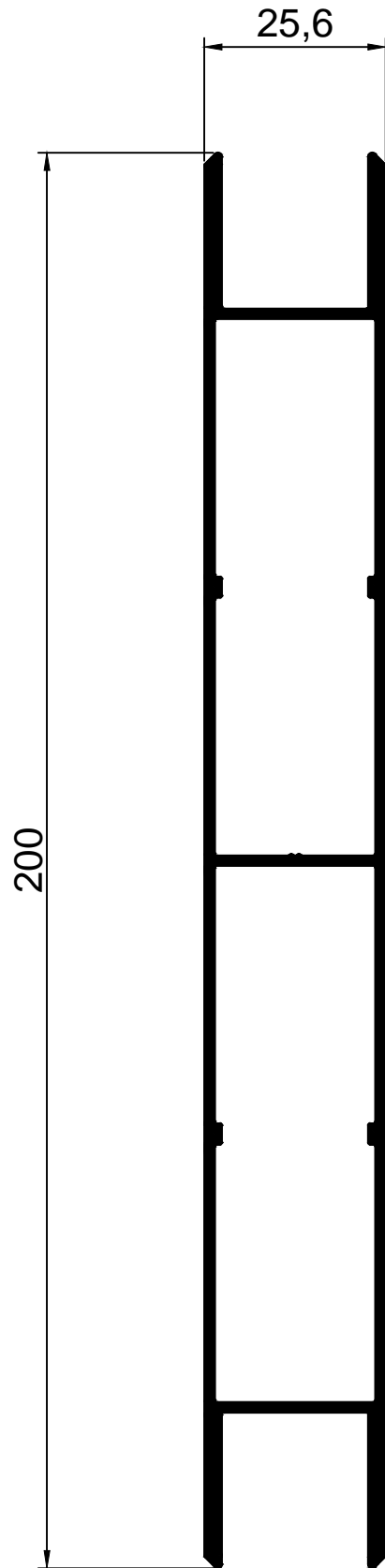

ALAS 01509

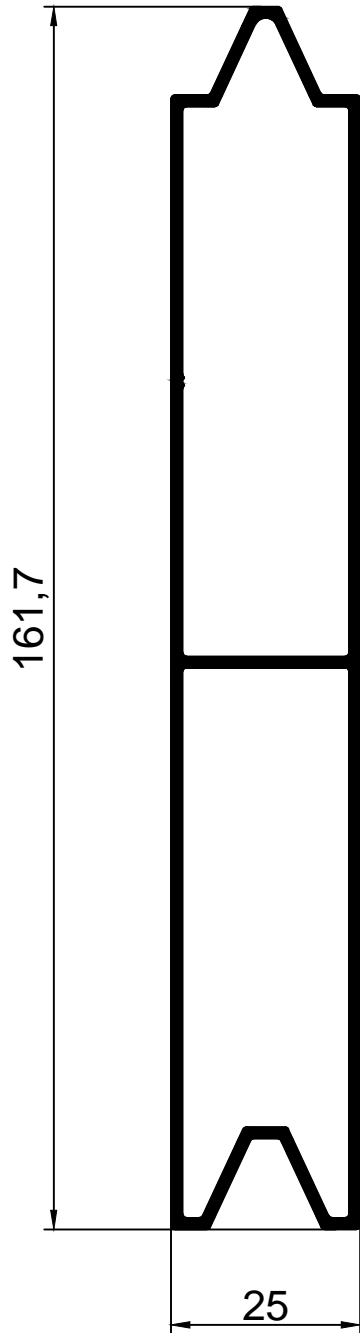

ALAS 01510

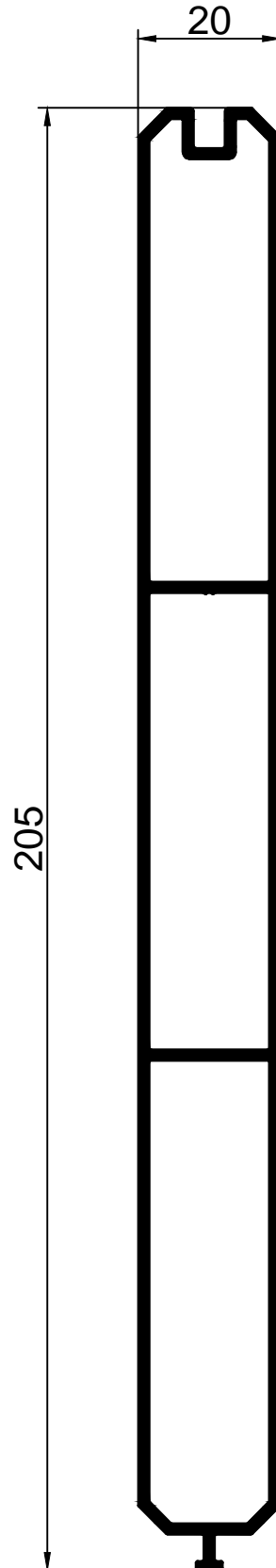

ALAS 01511



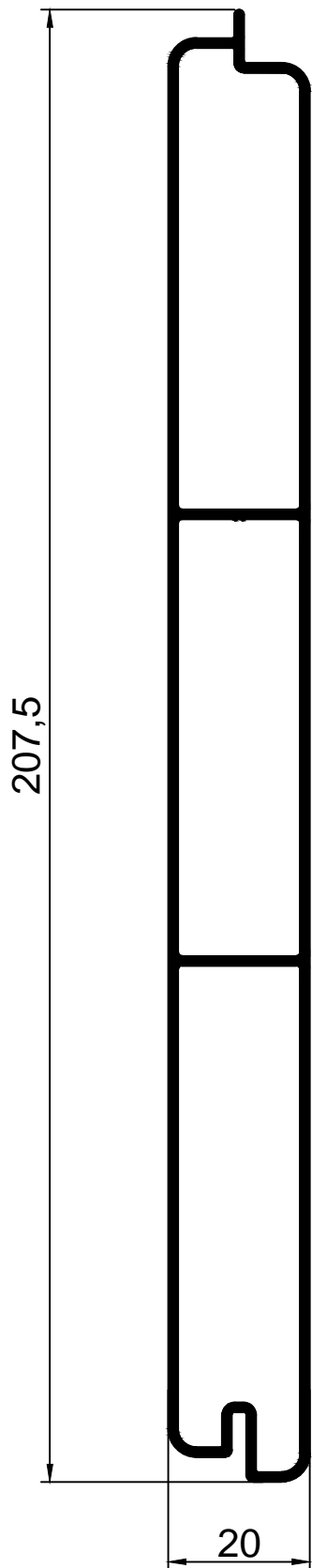

ALAS 01512

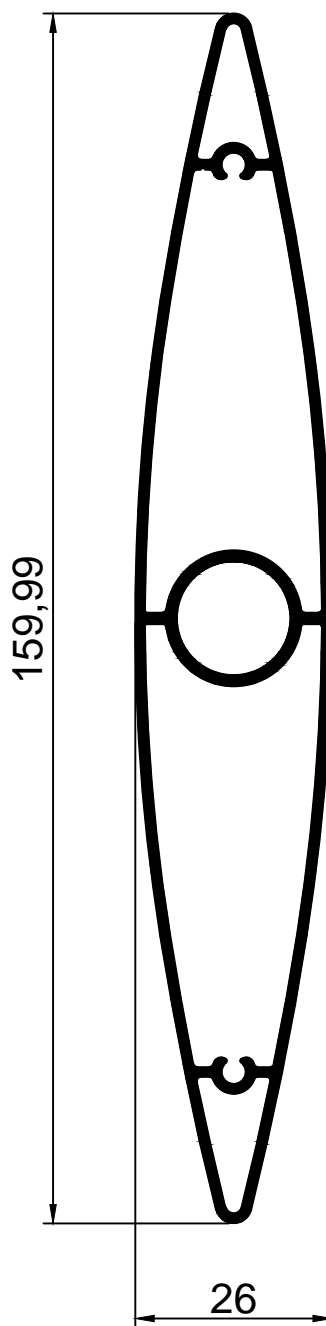

ALAS 01520

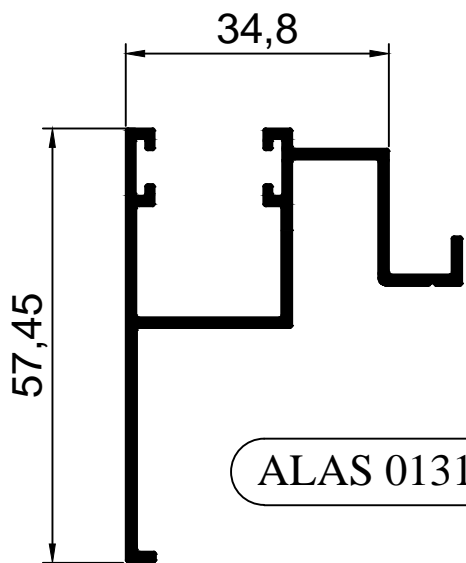

ALAS 01311

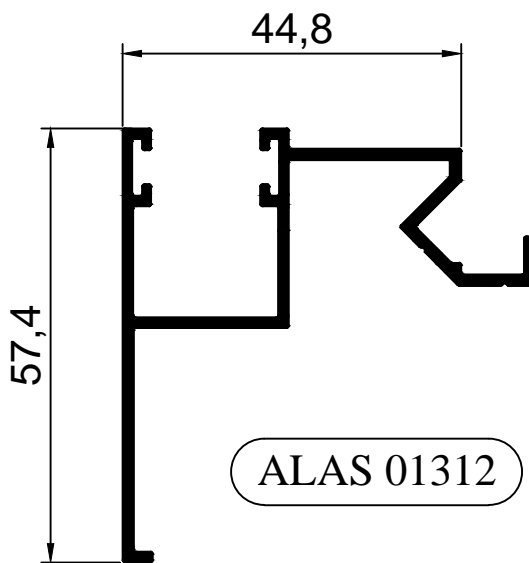

ALAS 01312

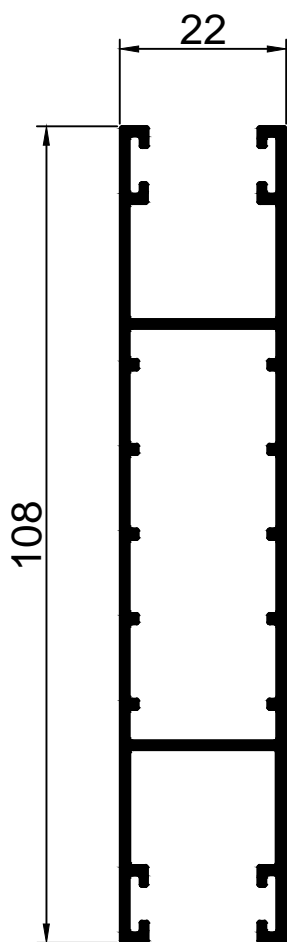

ALAS 01320

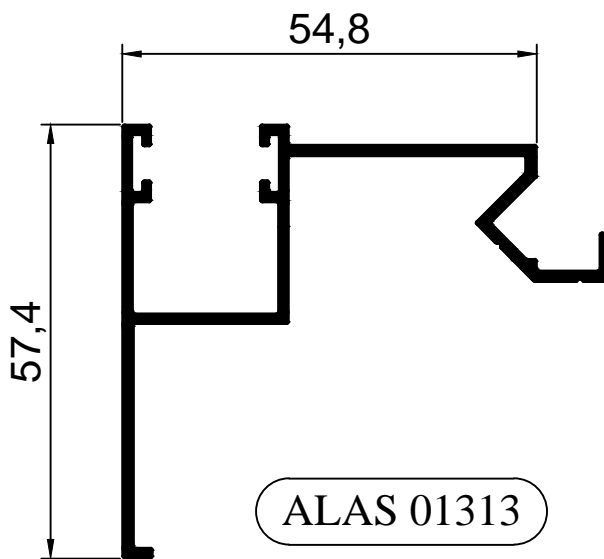

ALAS 01313

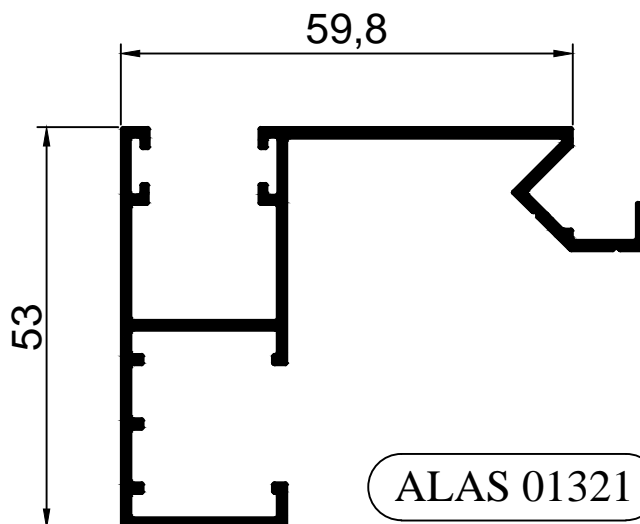

ALAS 01321

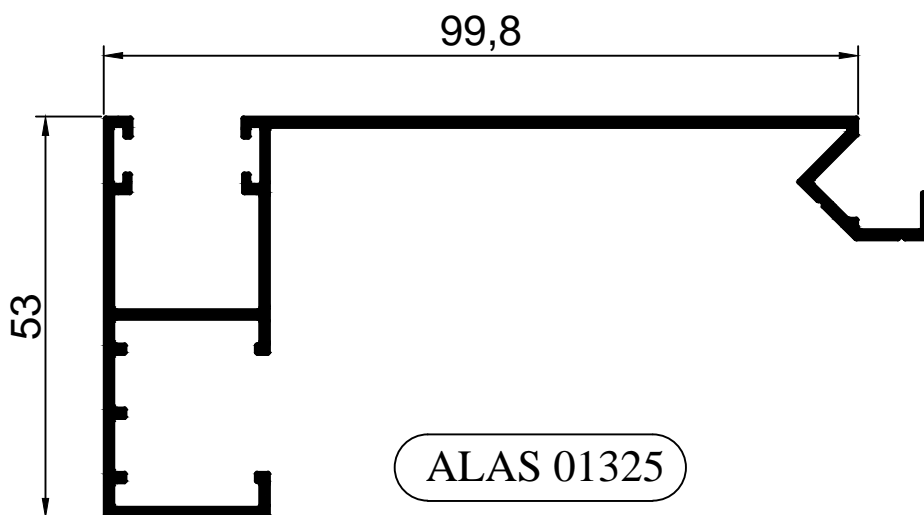
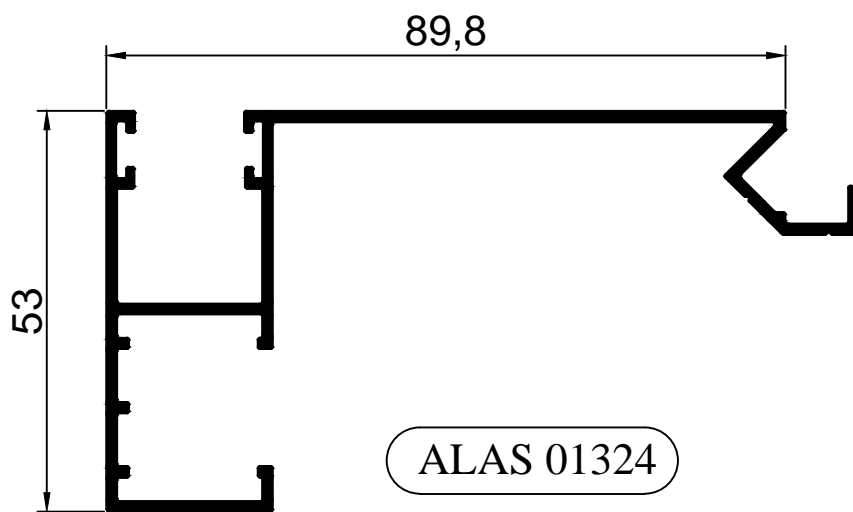
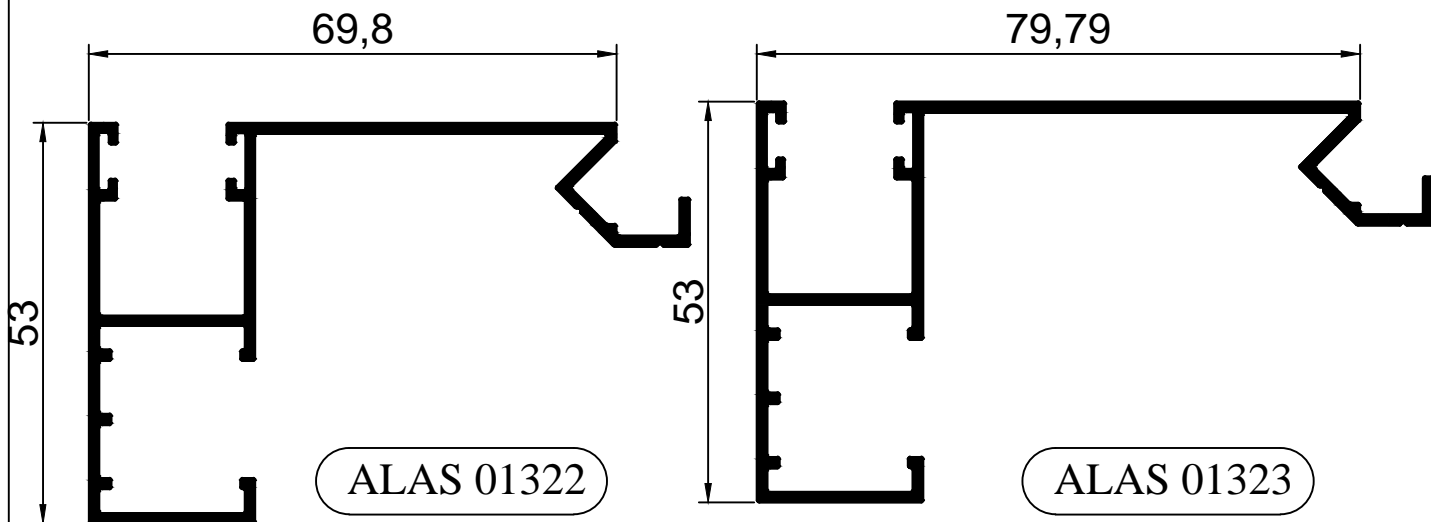

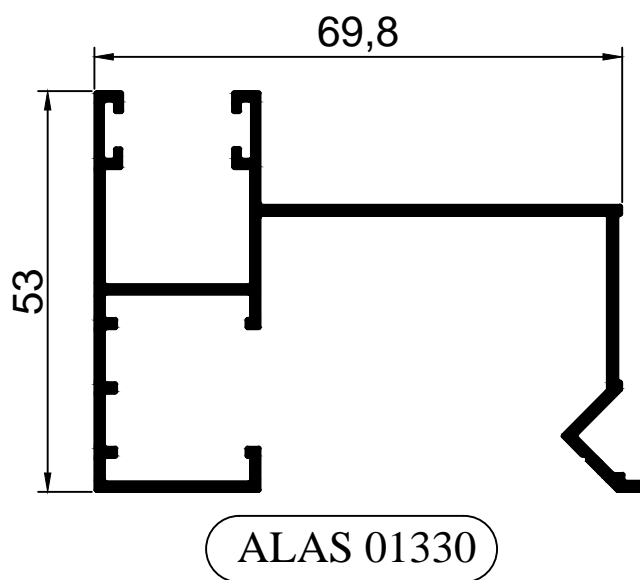
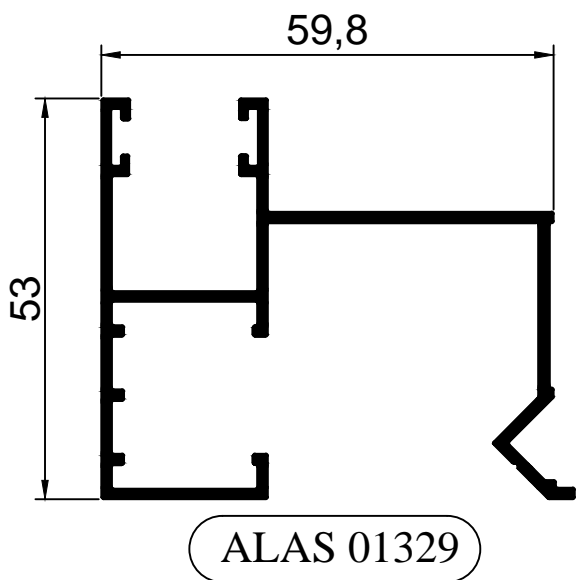
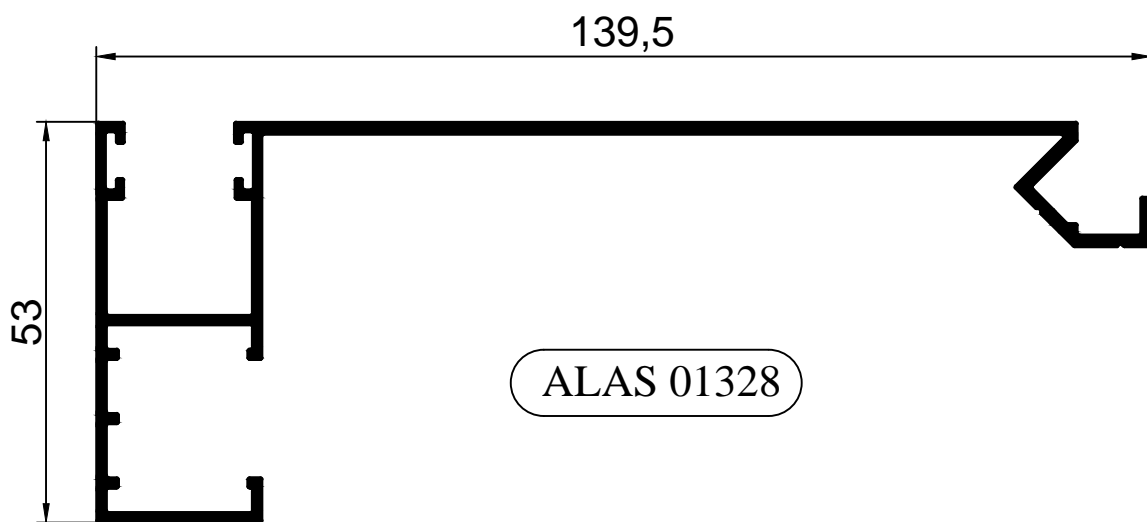
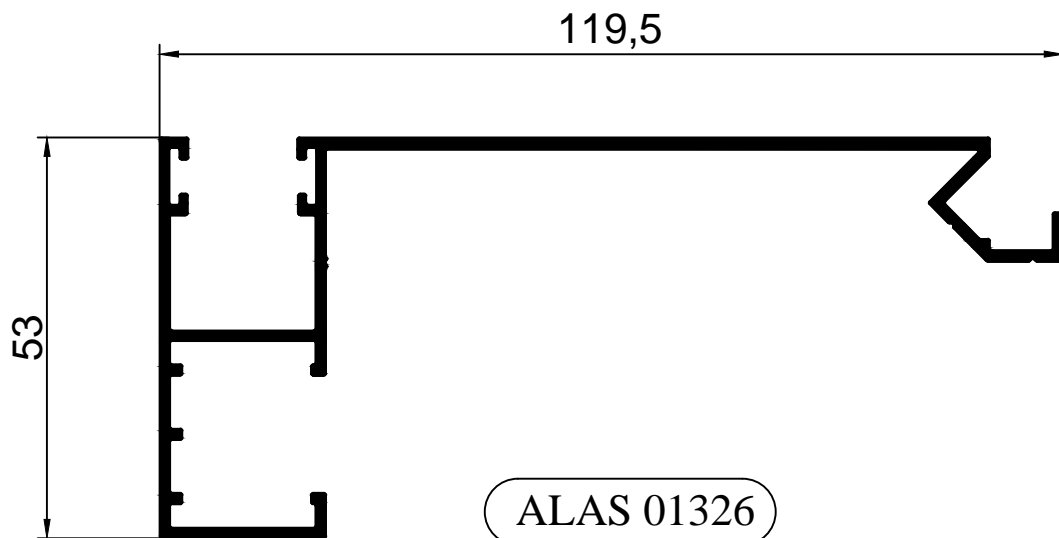

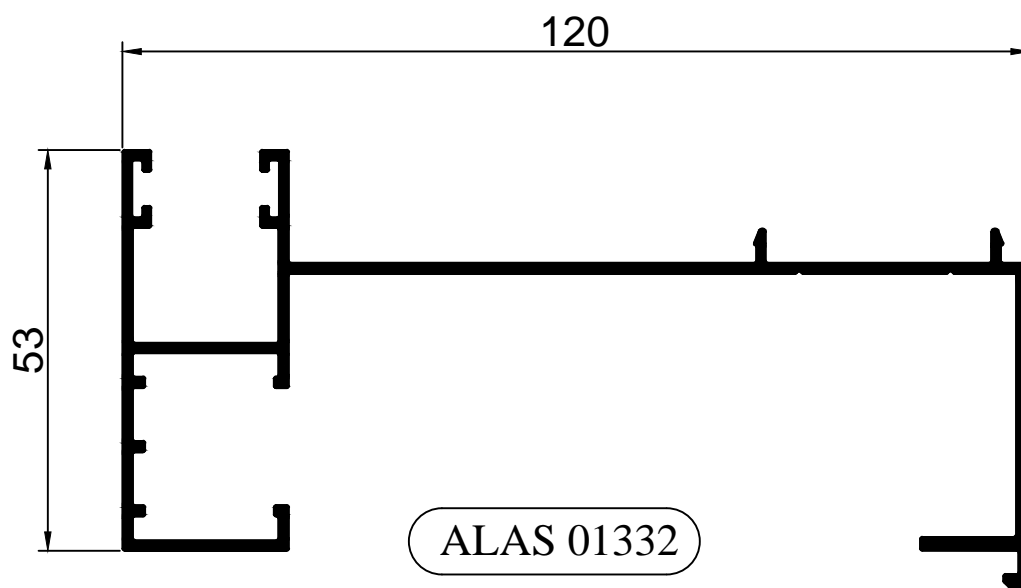
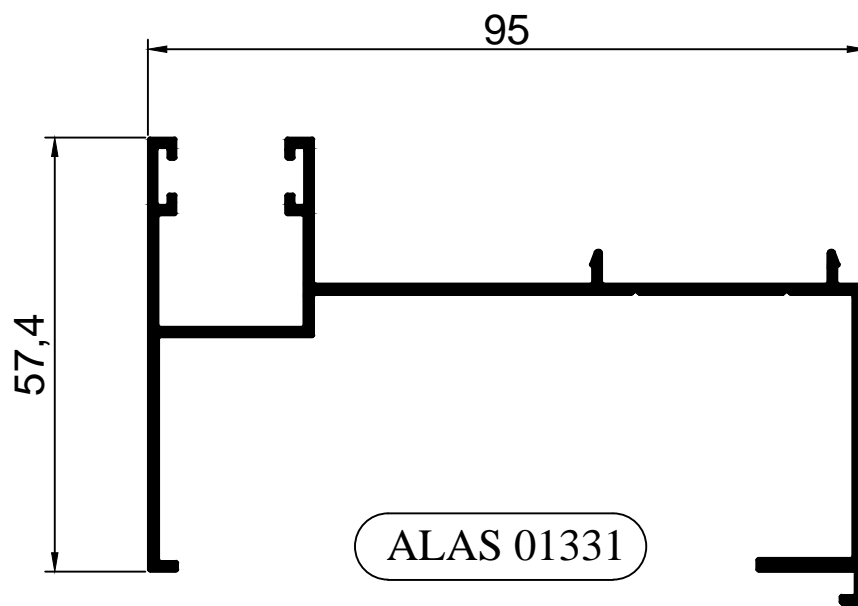

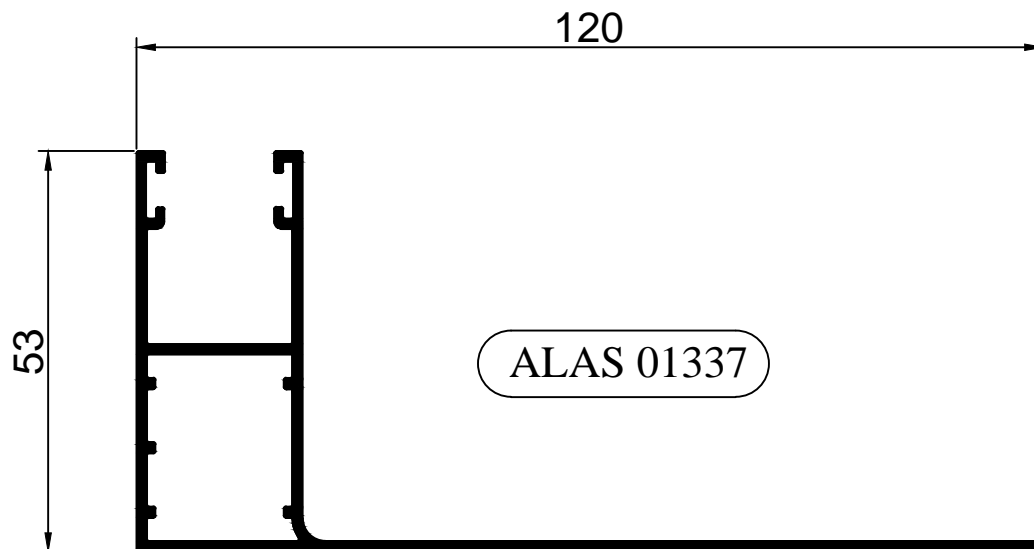
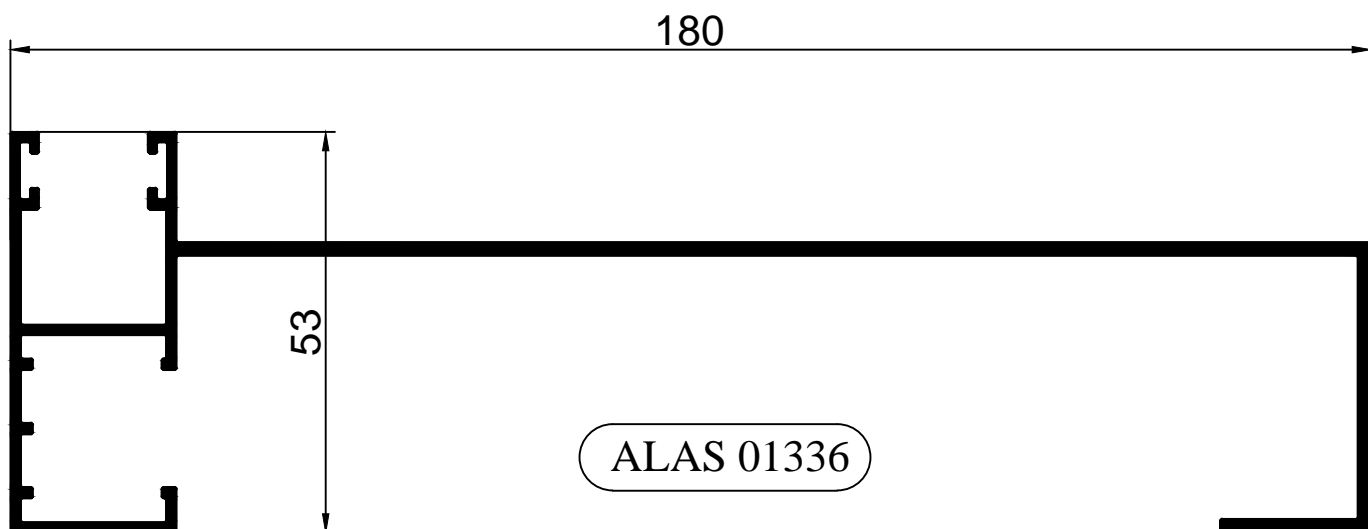
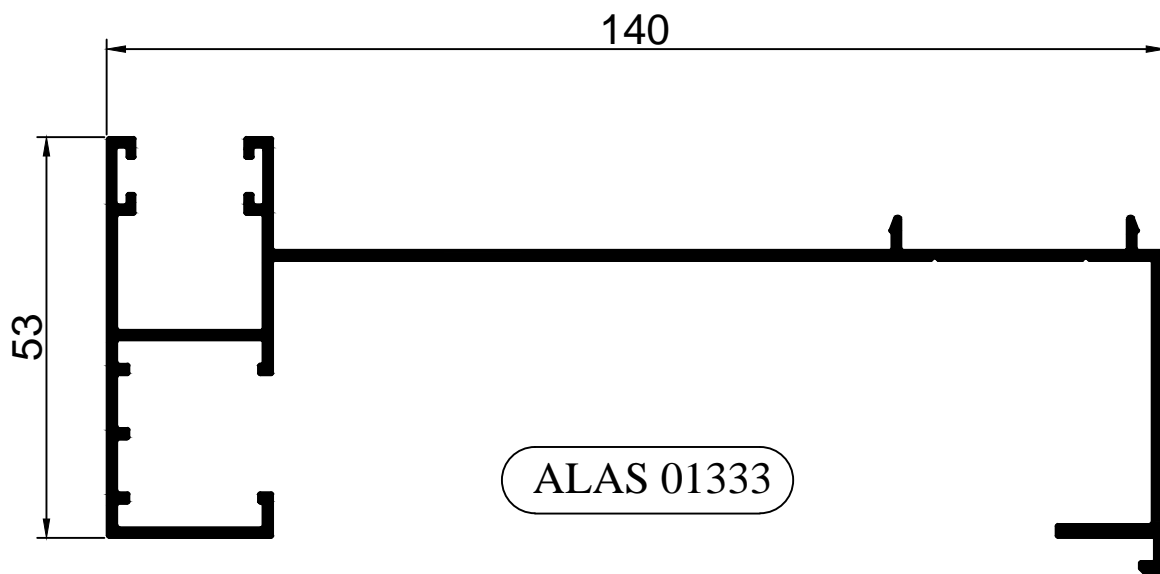

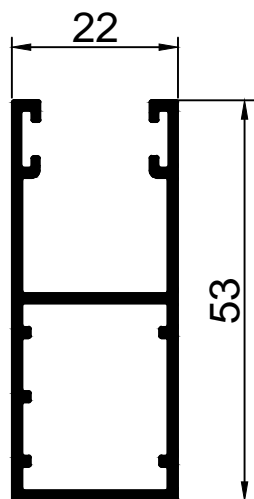

ALAS 01338

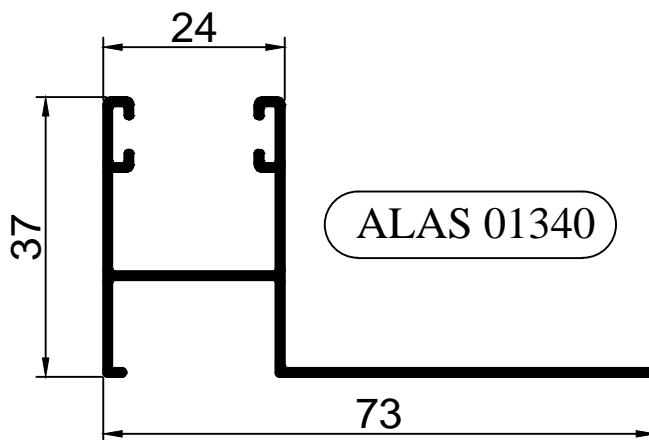

ALAS 01340

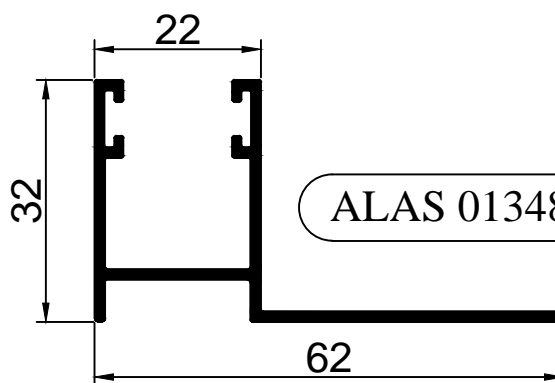

ALAS 01348

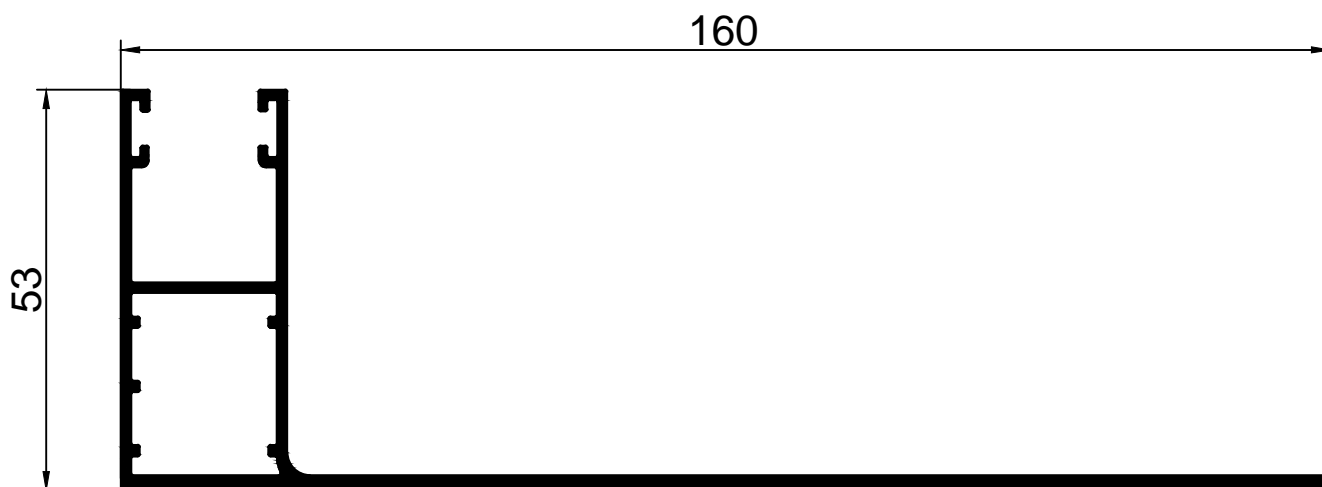

ALAS 01339

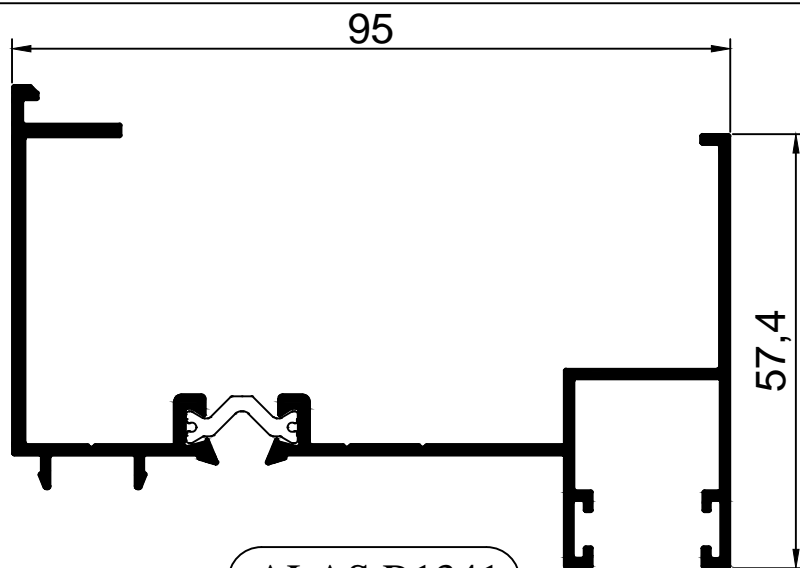

ALAS R1341

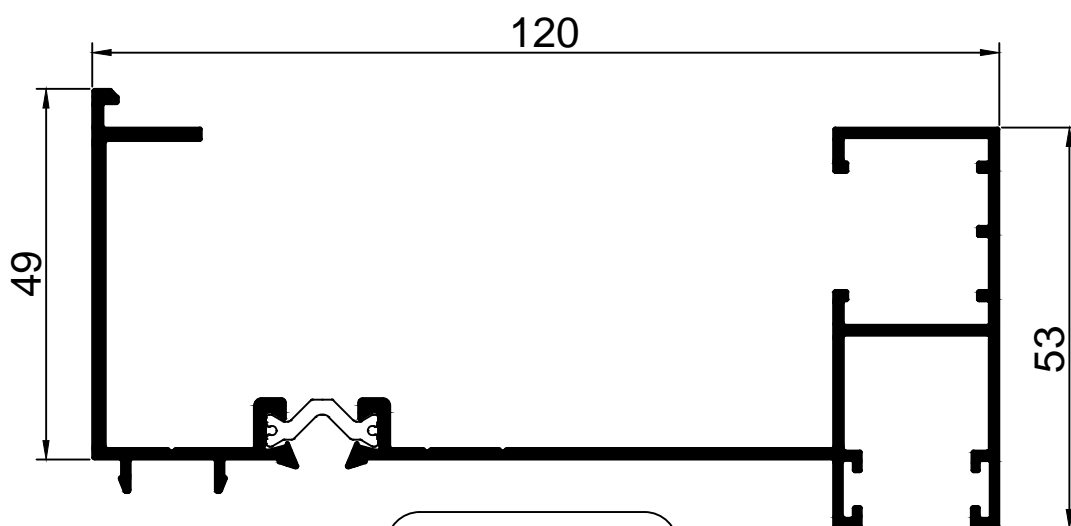

ALAS R1342

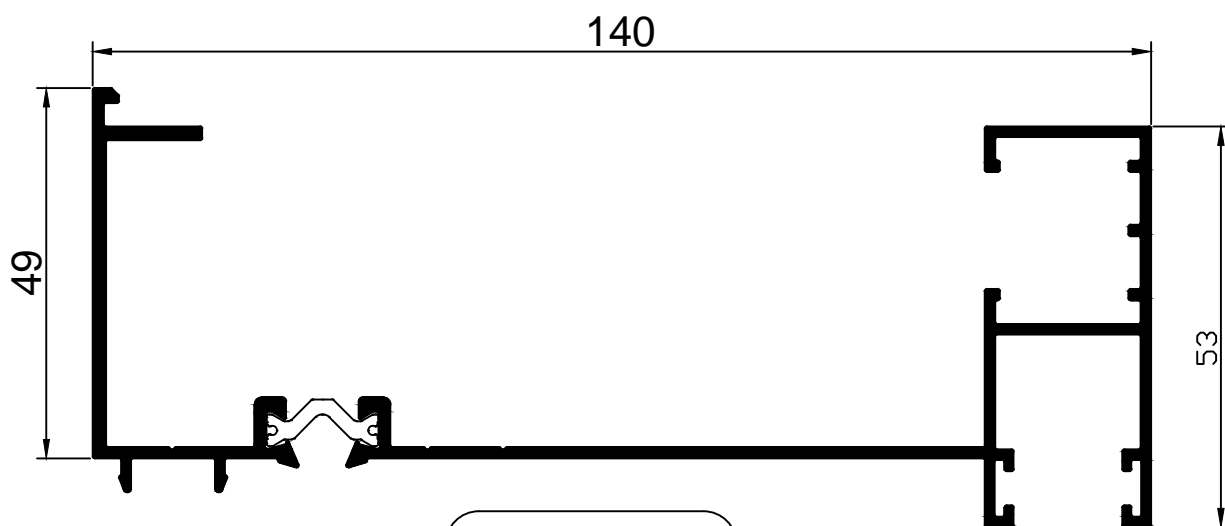

ALAS R1343



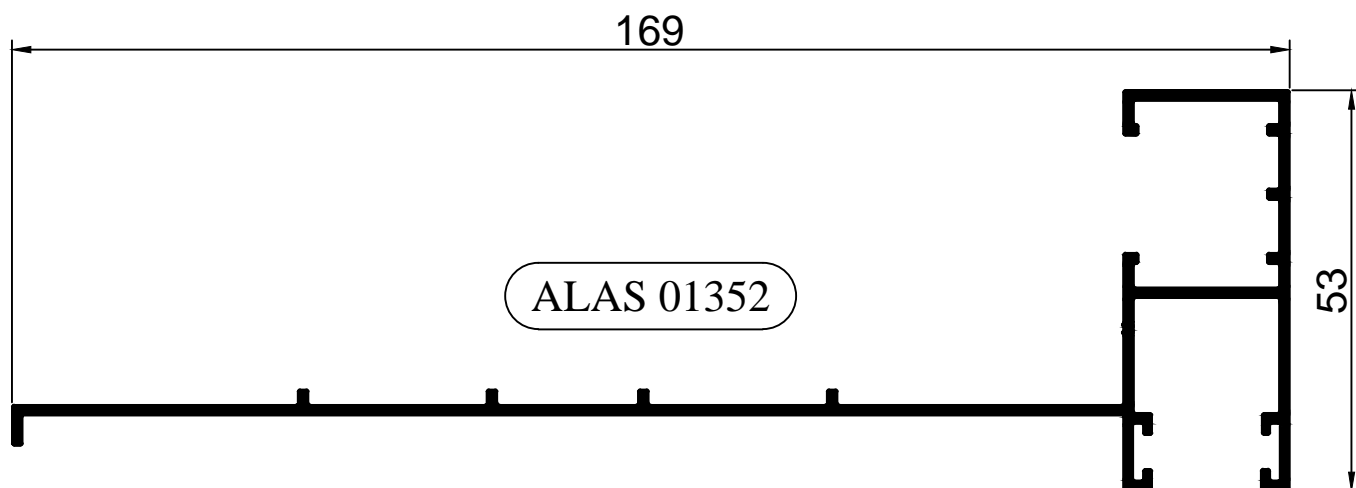
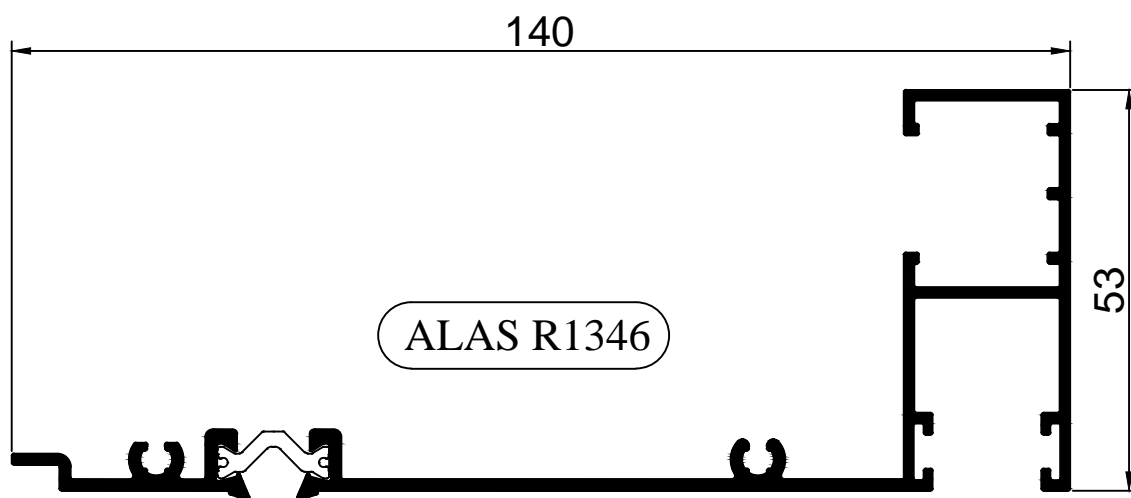
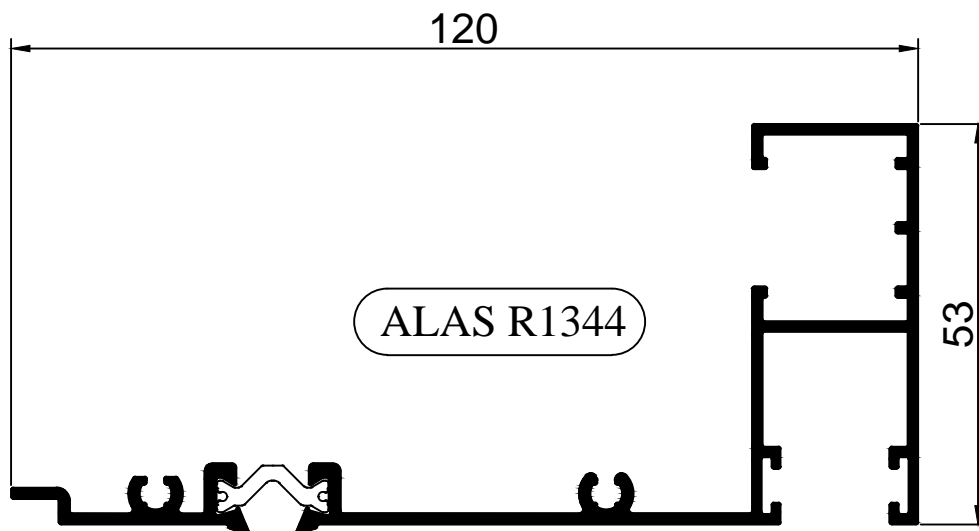

ALAS IA077

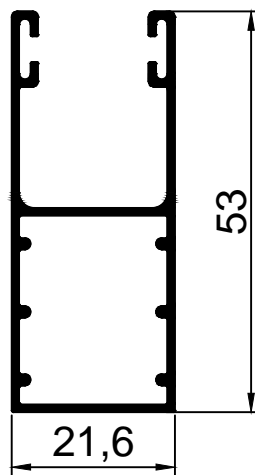

ALAS IA079

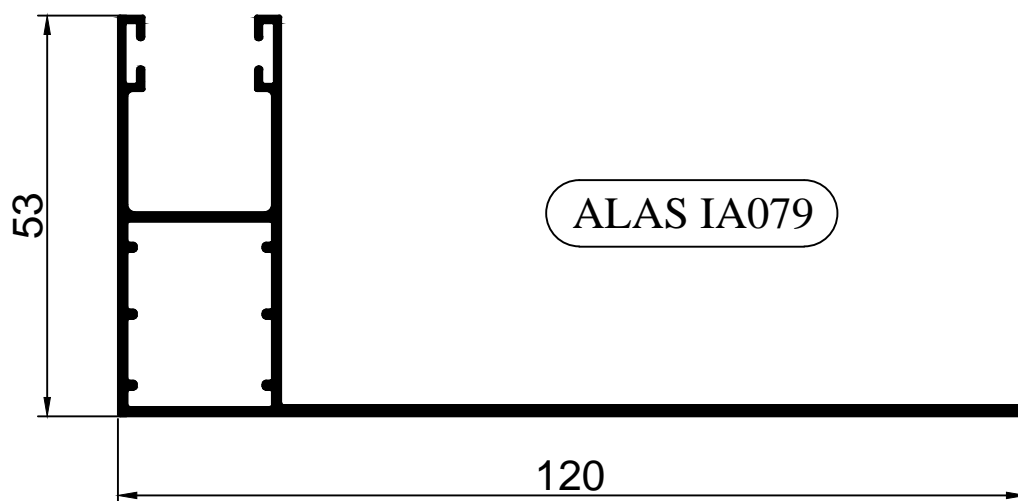

ALAS IB467

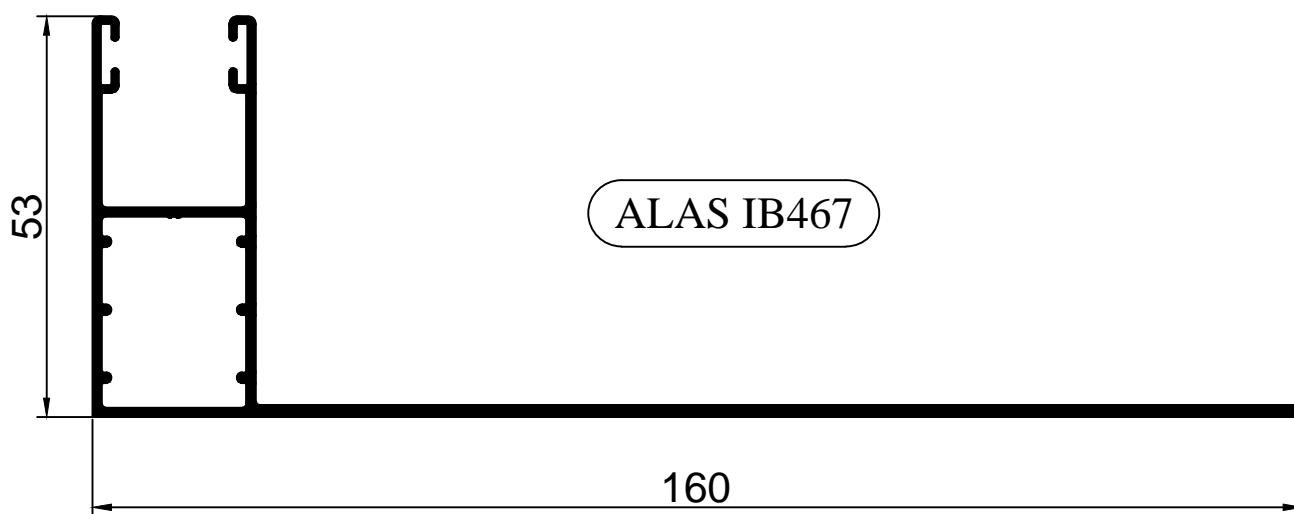

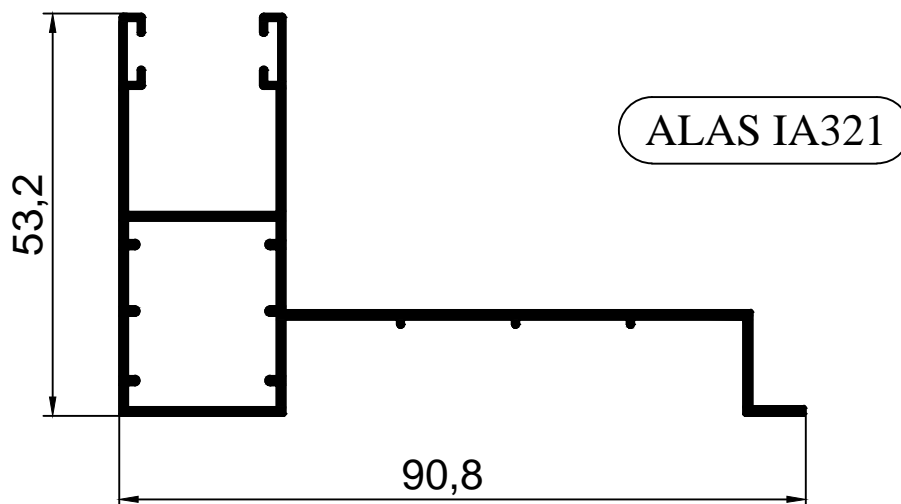
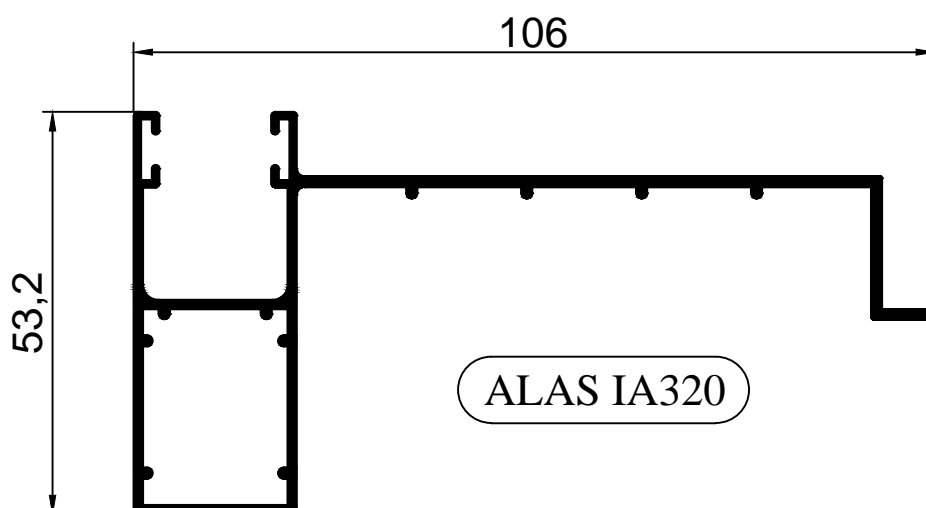
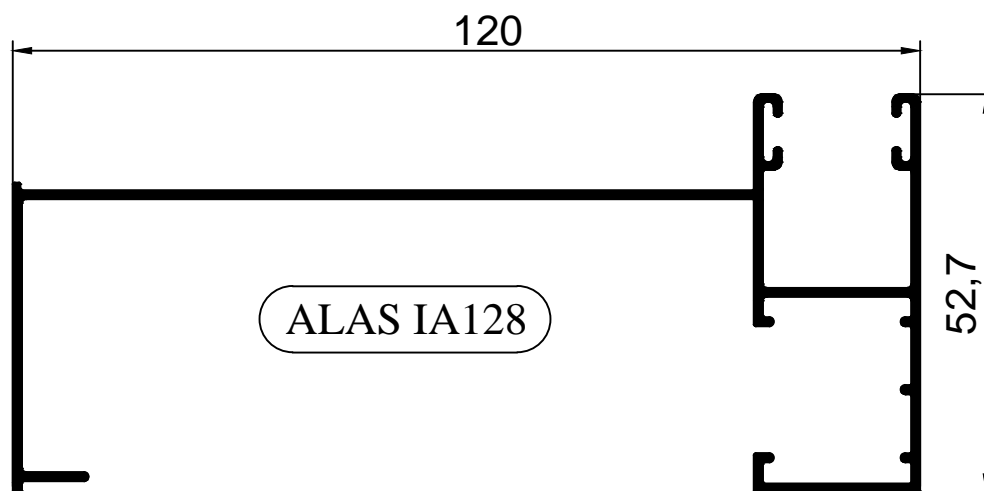

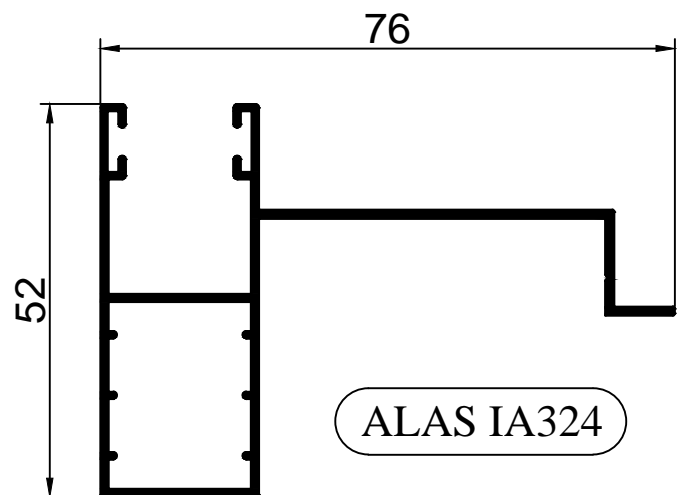
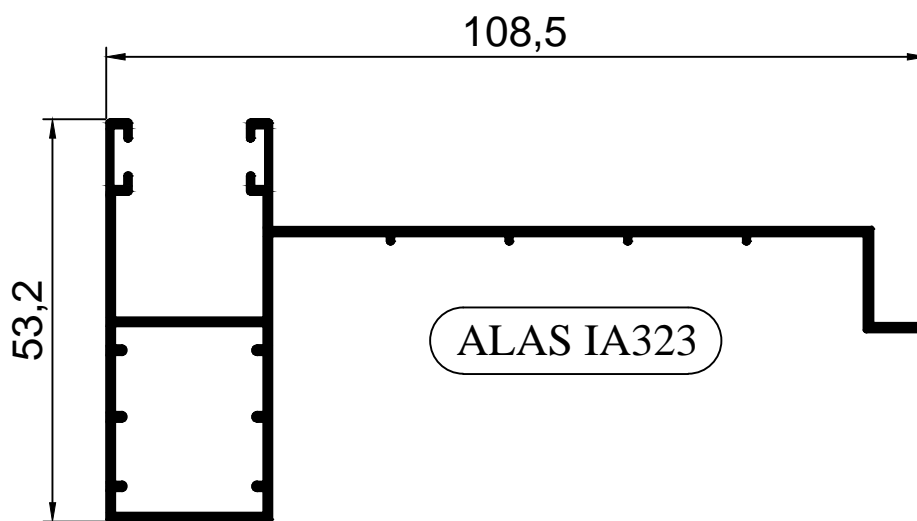
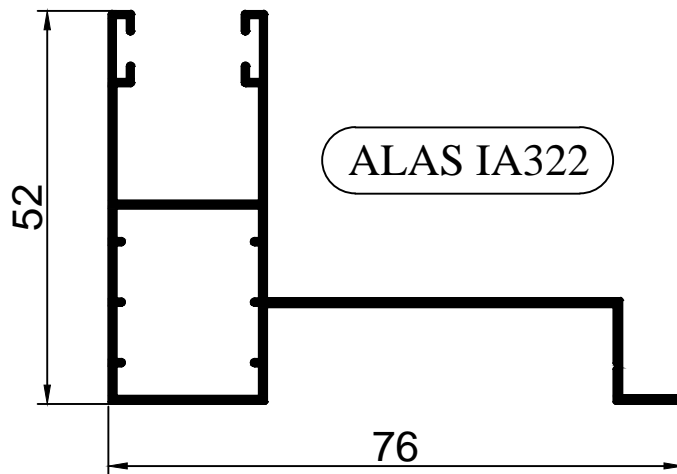

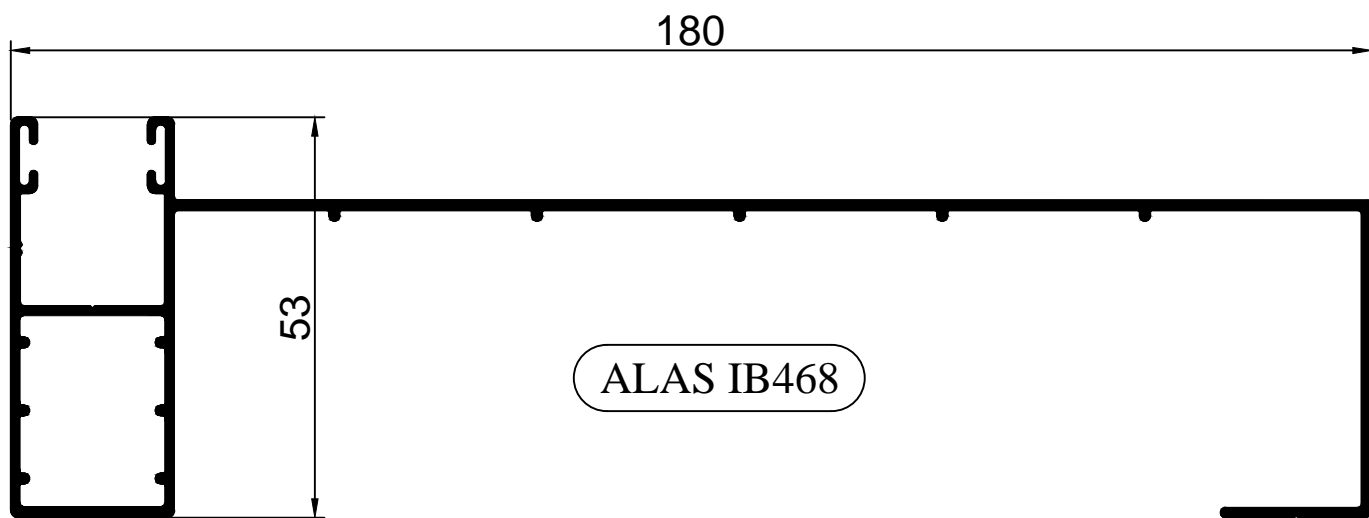
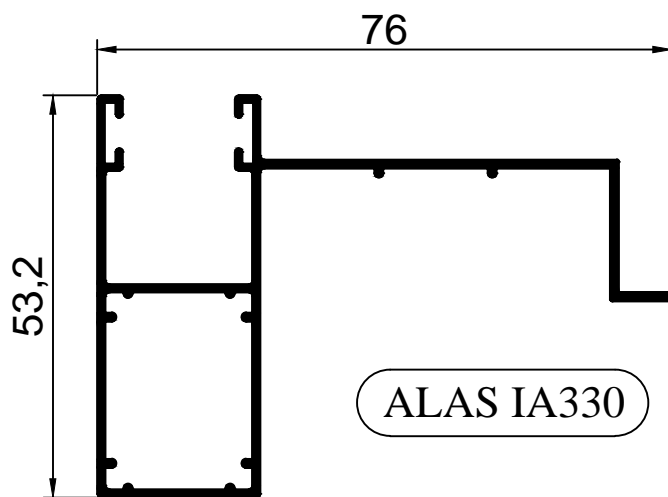
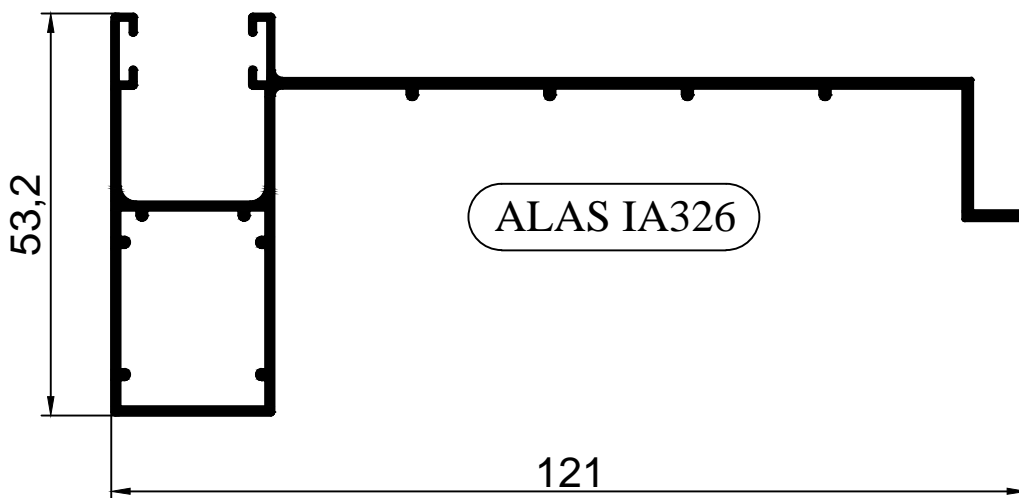

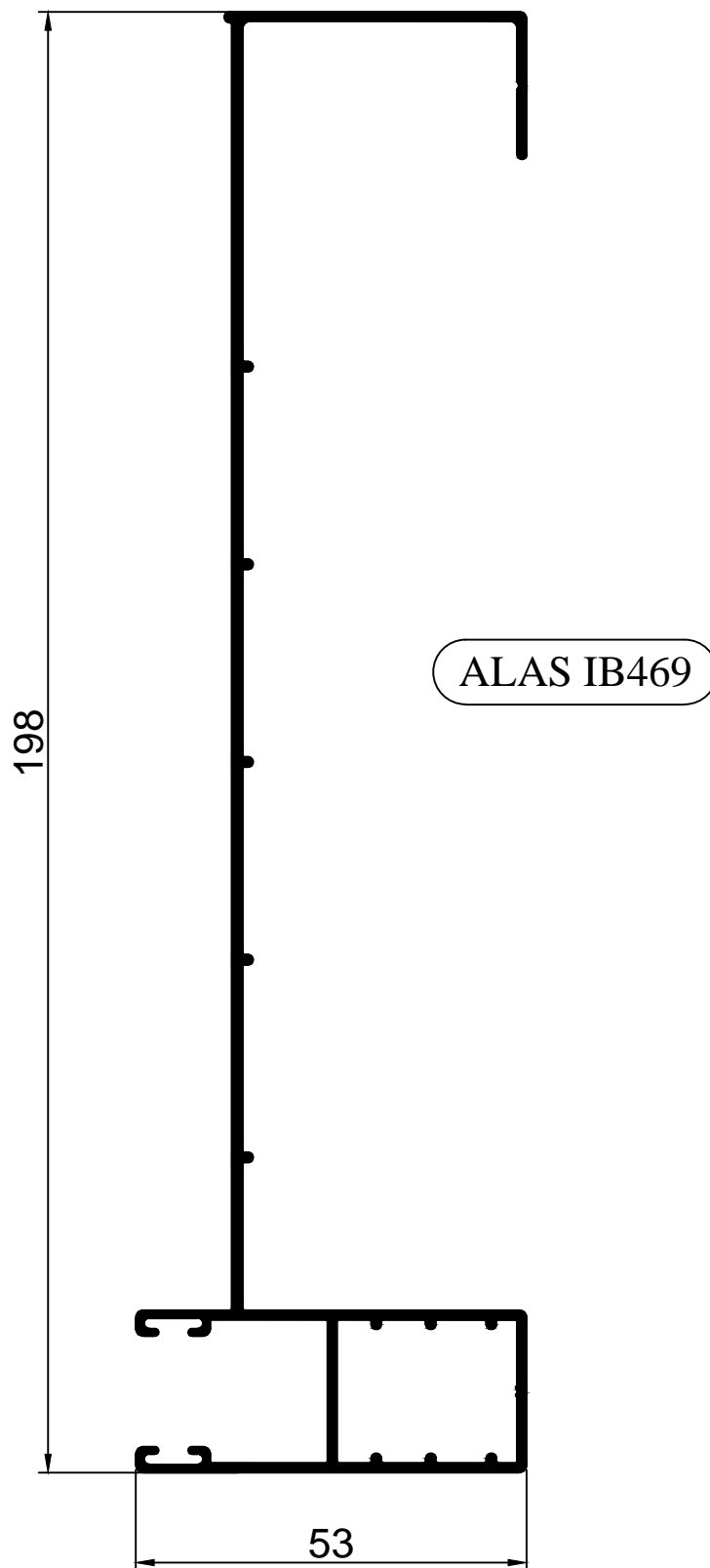

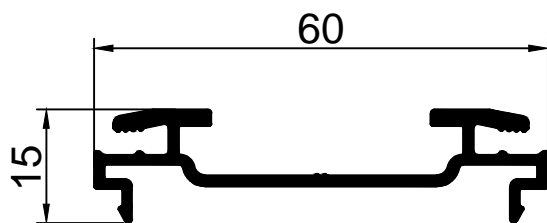

ALAS 01358

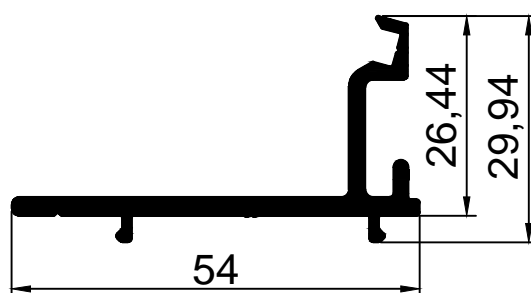

ALAS 01359

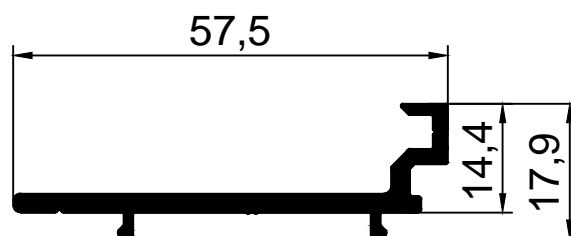

ALAS 01360

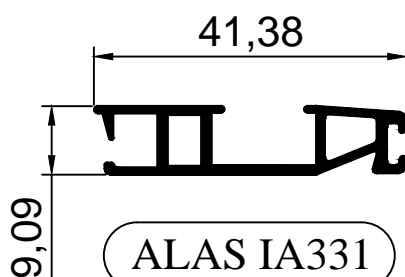

ALAS IA331

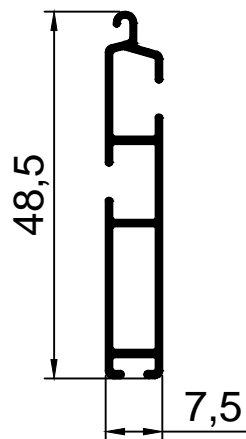

ALAS IA078

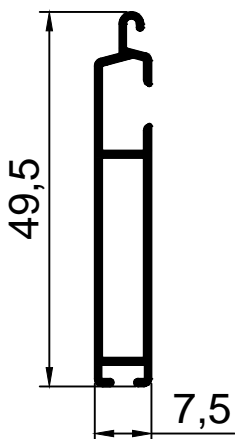

ALAS IA329

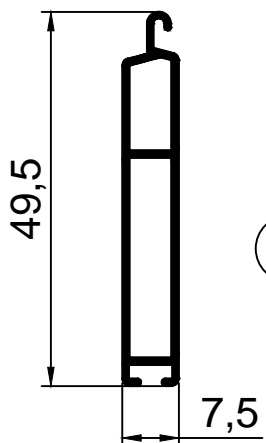

ALAS IA328



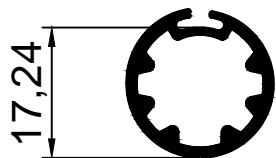

ALAS IA325

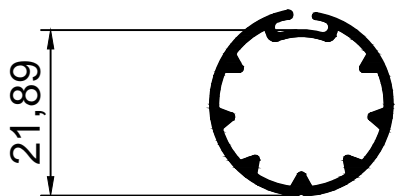

ALAS IA327

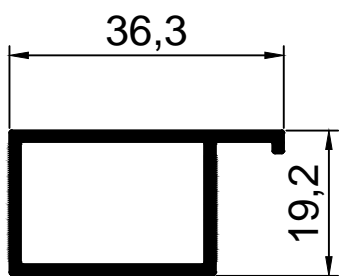

ALAS 01401

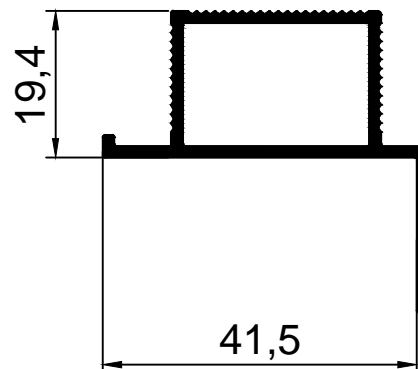

ALAS 01402

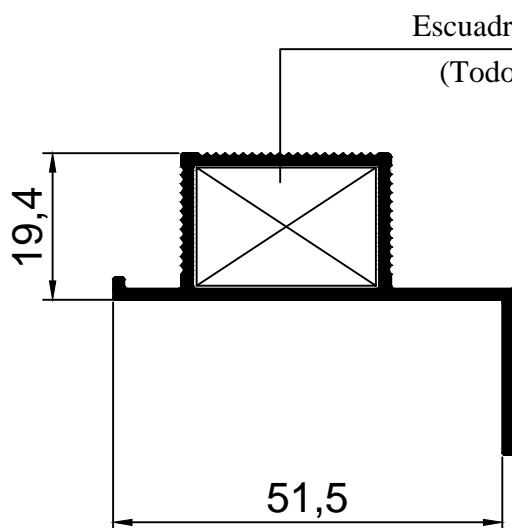

ALAS 01403

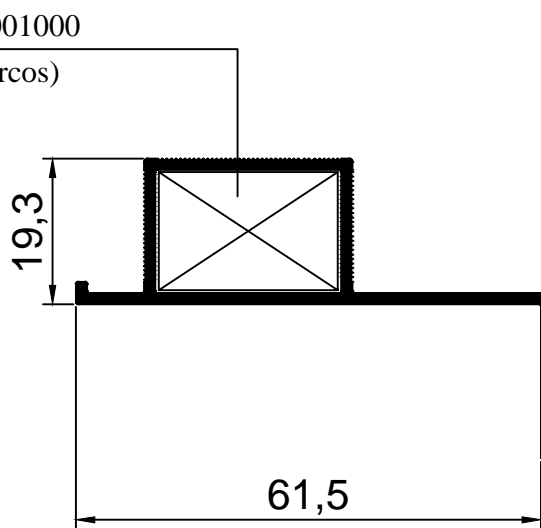

ALAS 01404

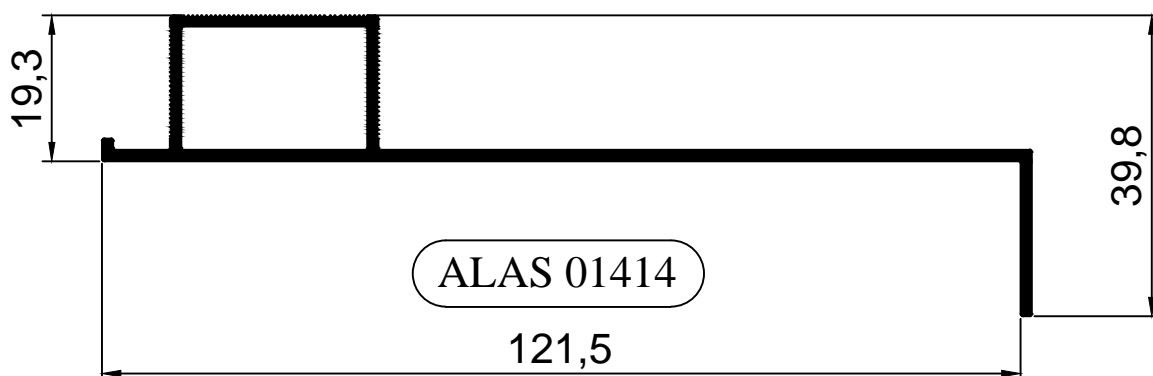
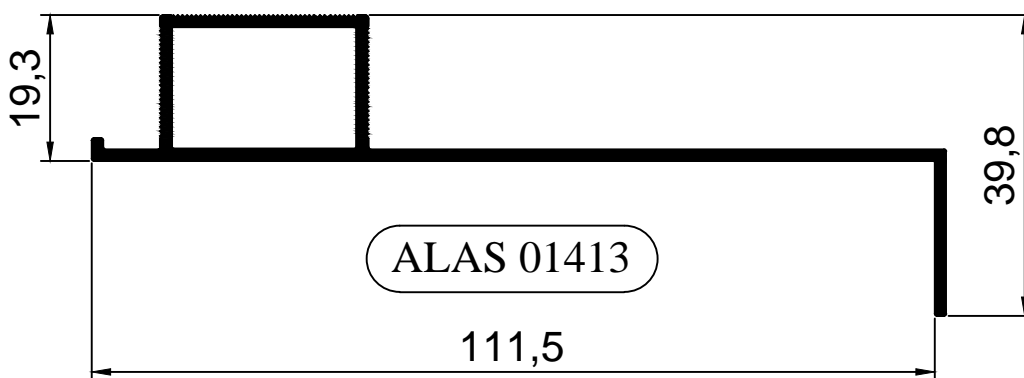
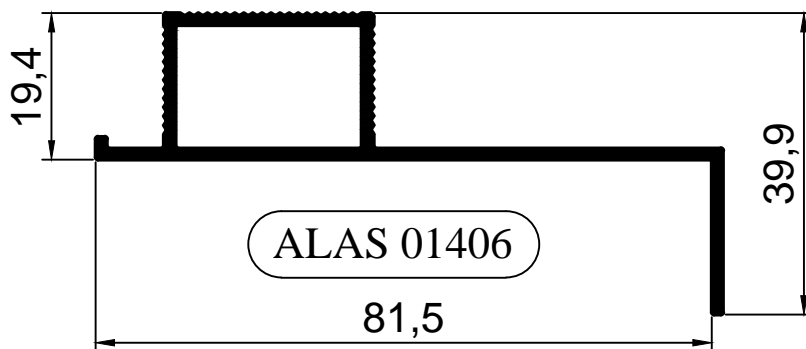
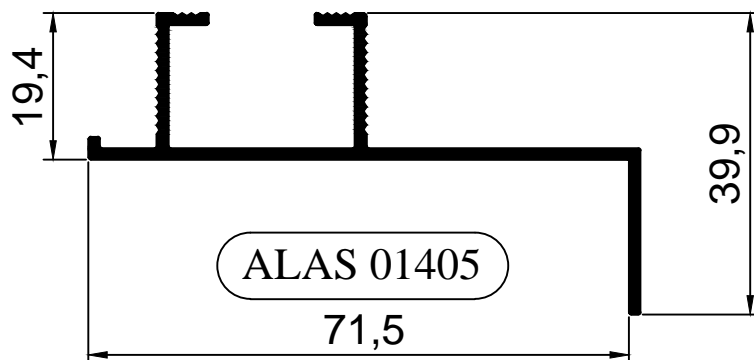

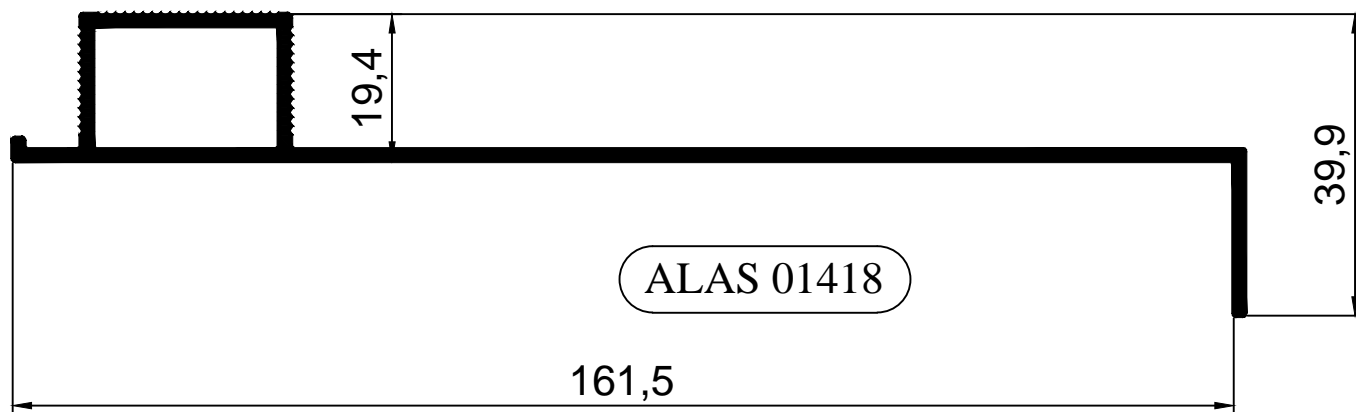
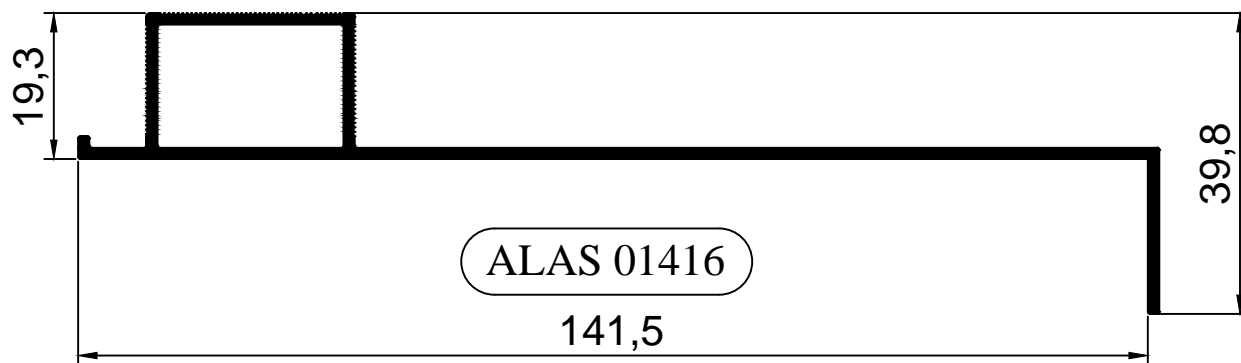
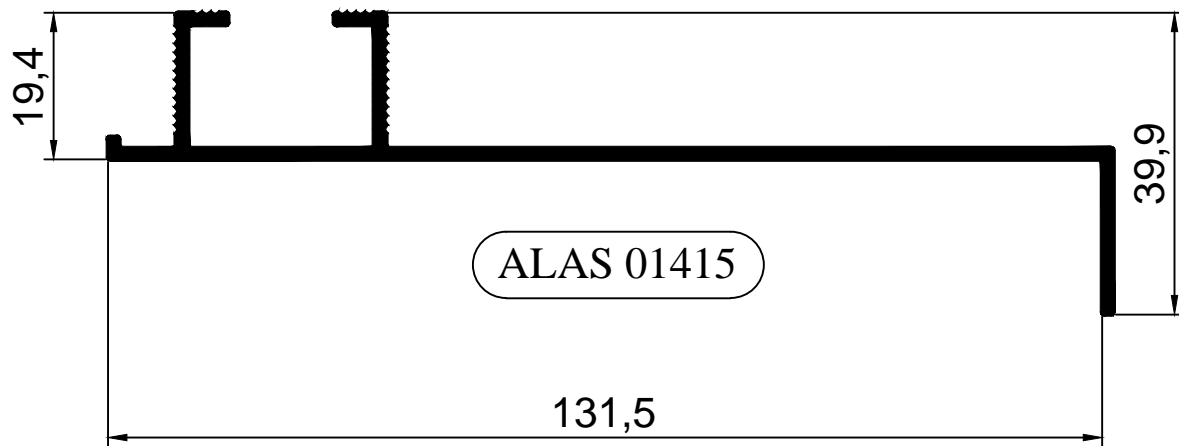

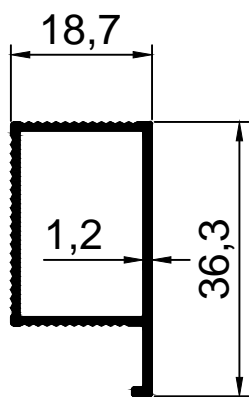
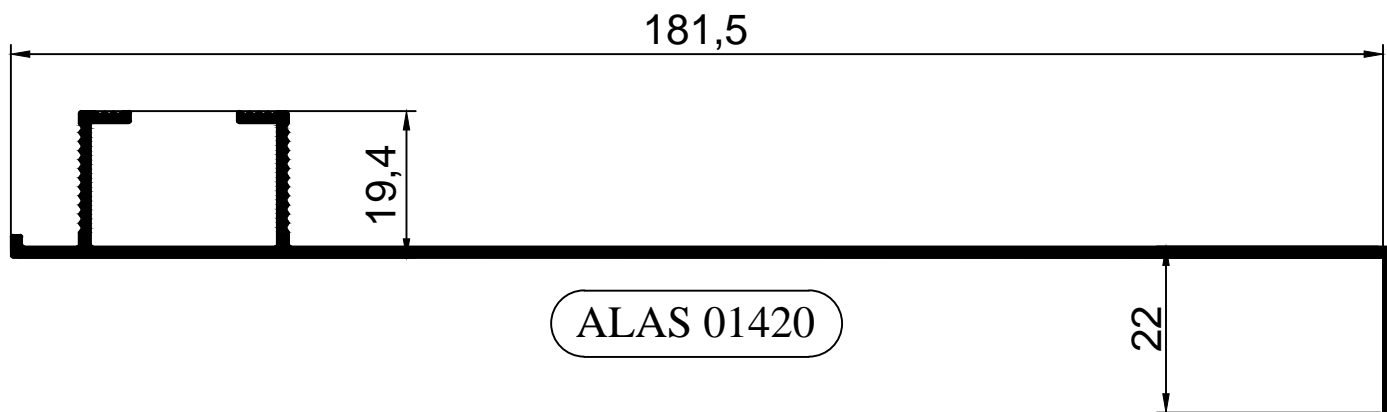

ALAS 01421

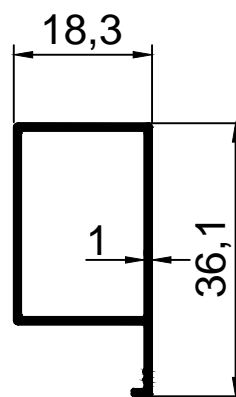

ALAS 01421

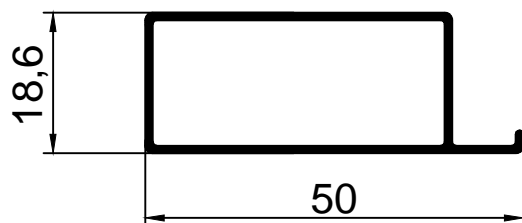

ALAS 01423

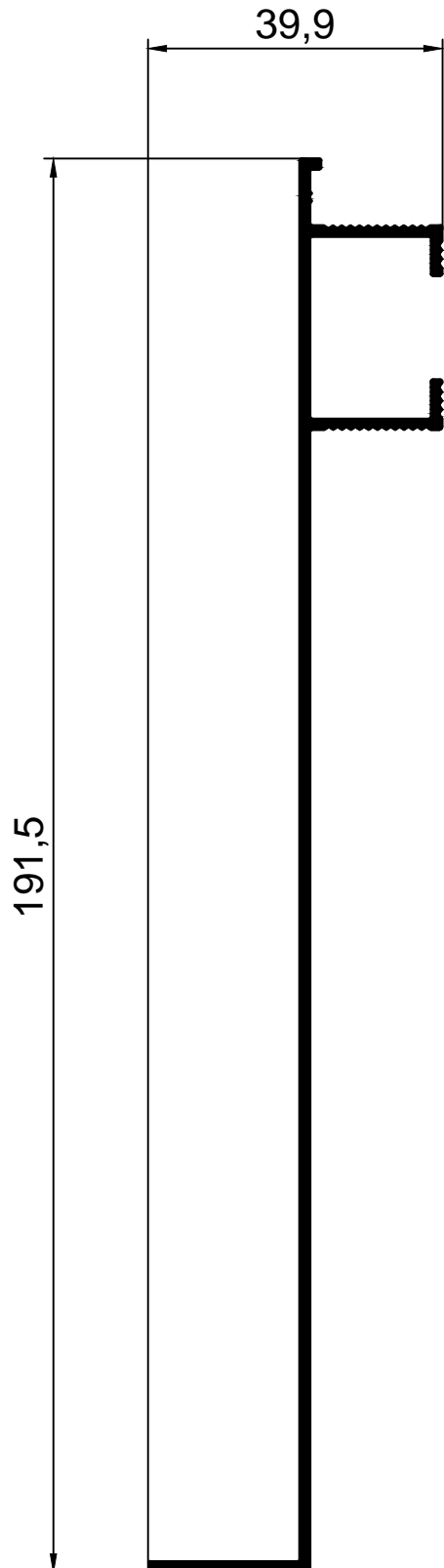

ALAS 01422

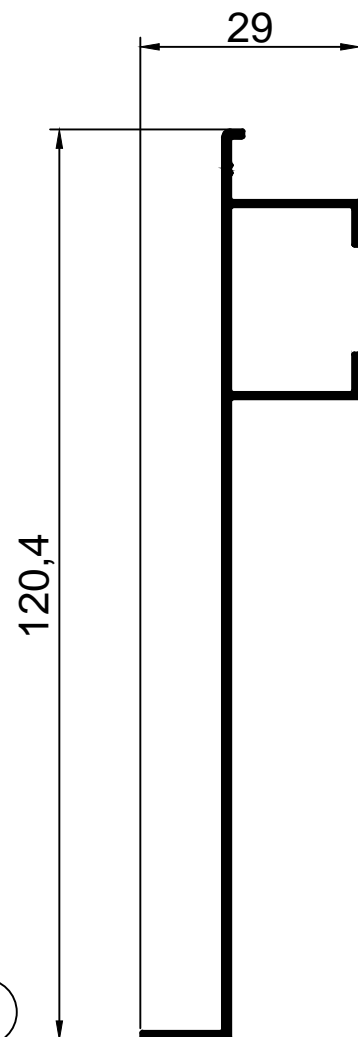

ALAS 01425

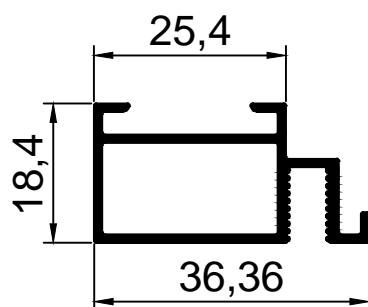

ALAS 01430

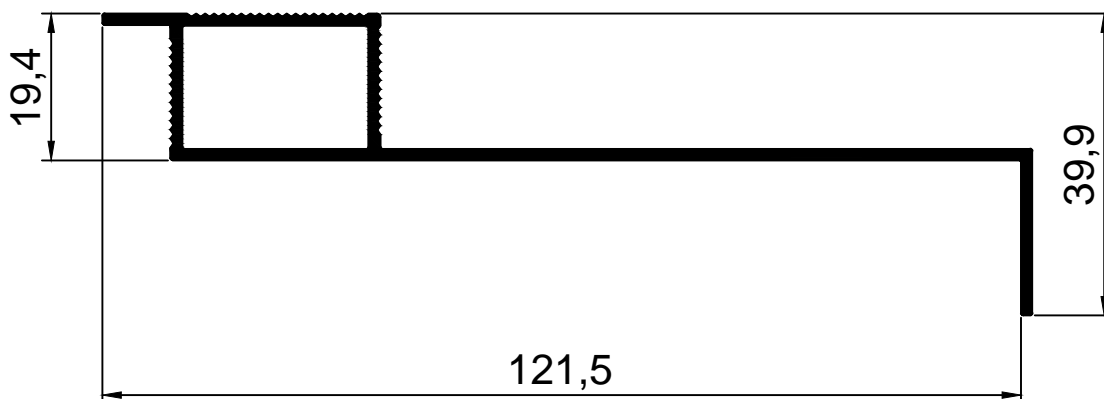

ALAS 01434

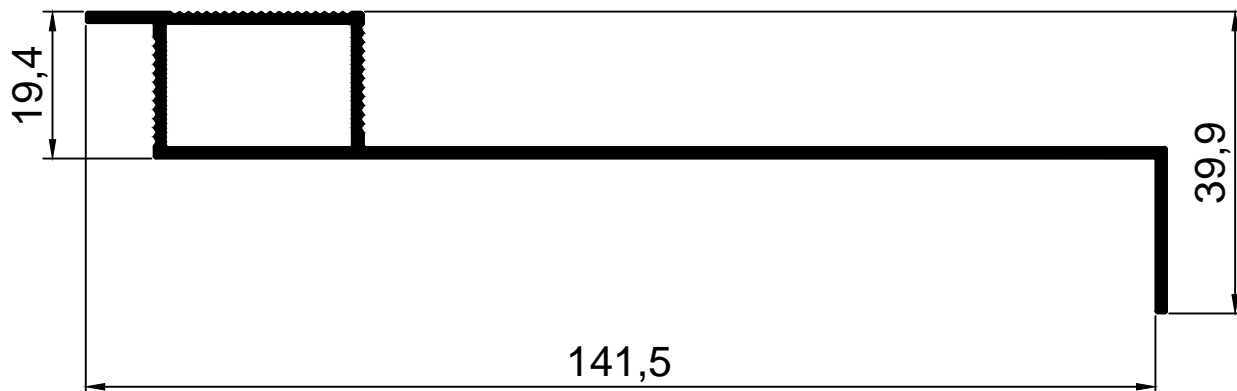

ALAS 01436

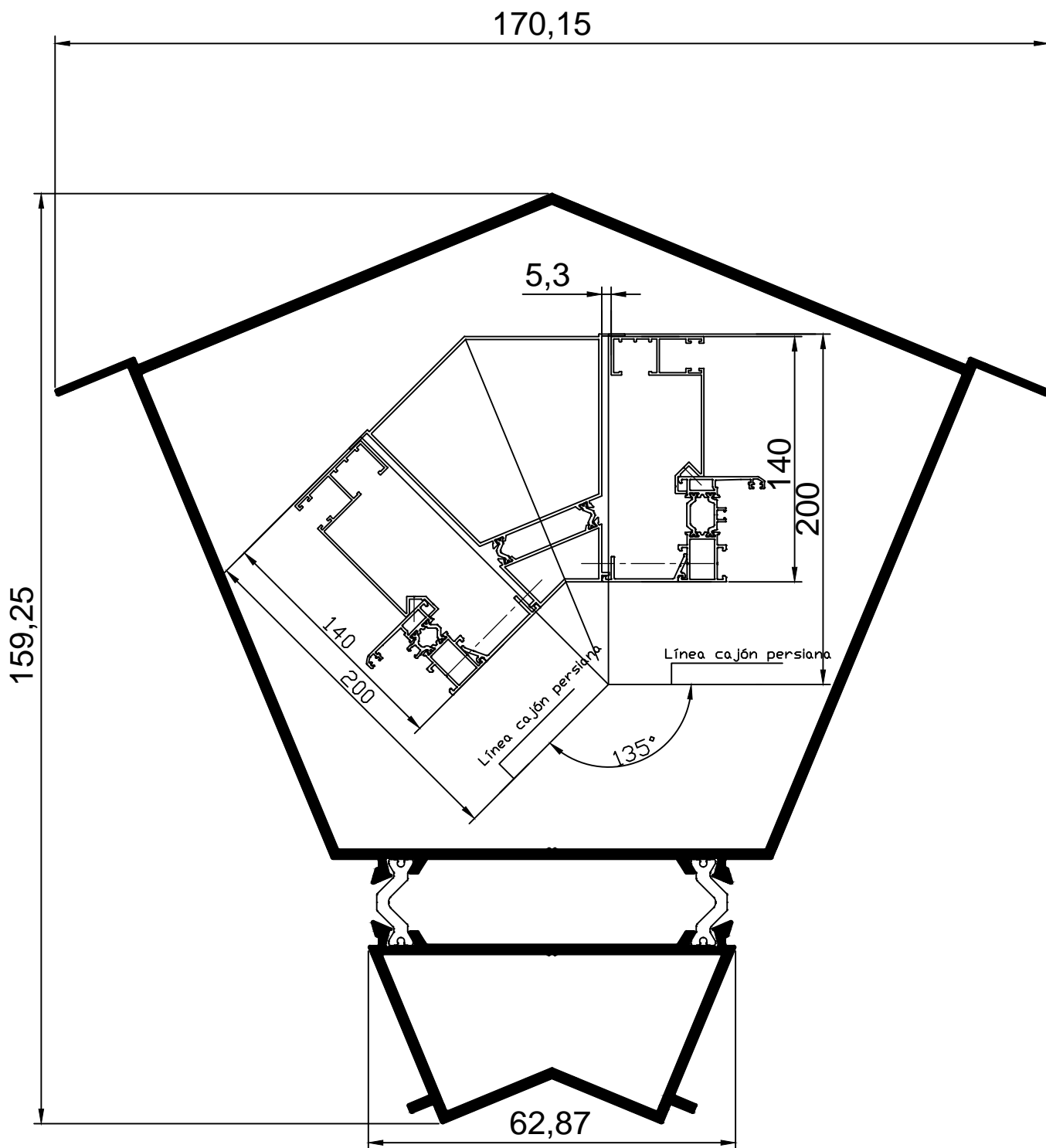

ALAS R1243



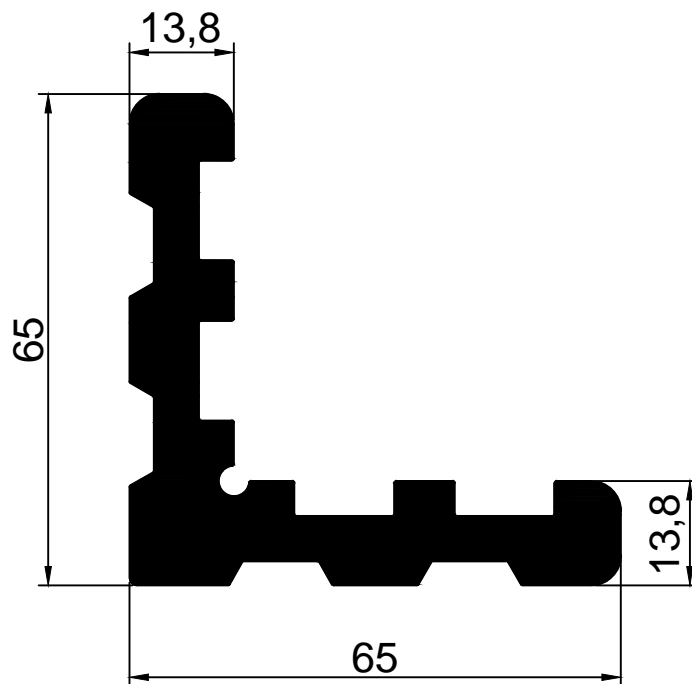

ALAS 01481

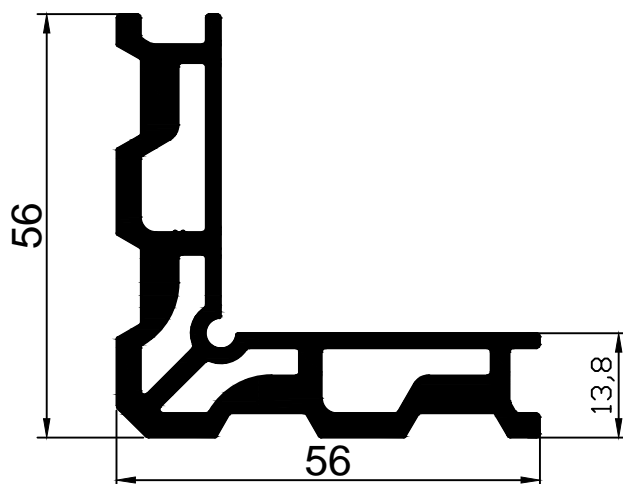

ALAS 01482

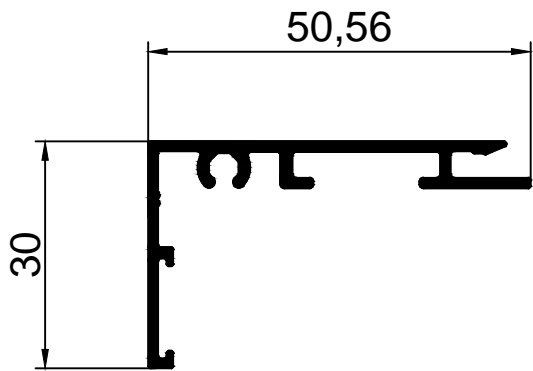

ALAS 01701

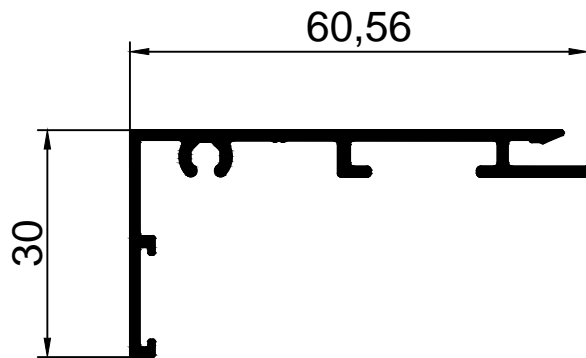

ALAS 01702

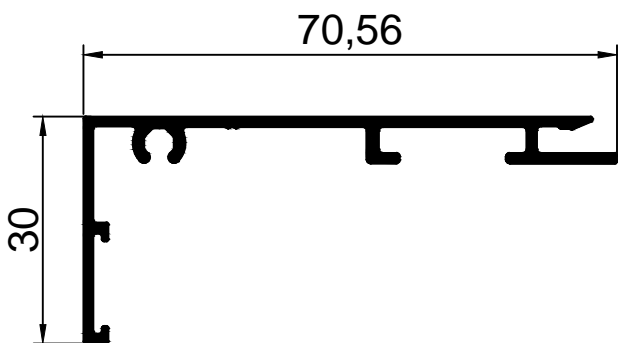

ALAS 01703

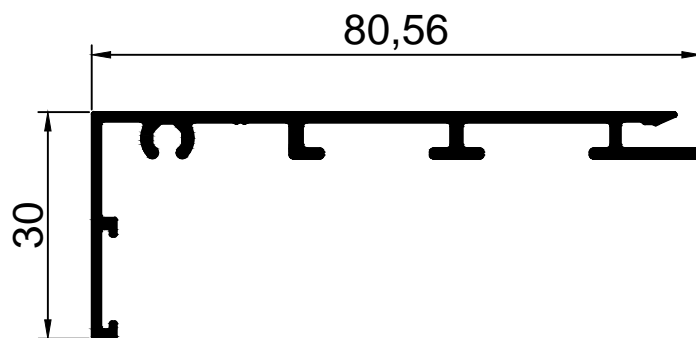

ALAS 01704

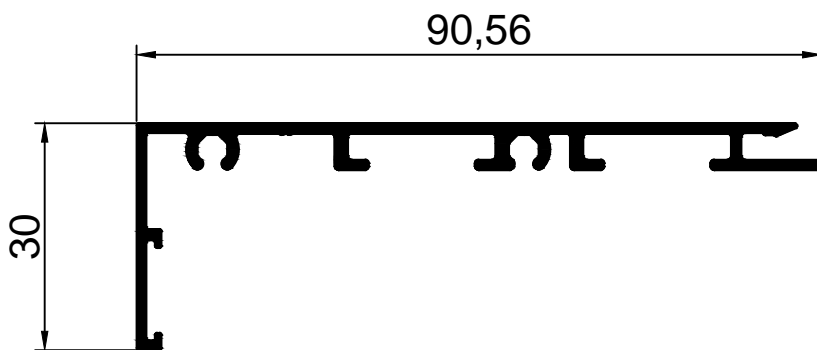

ALAS 01705

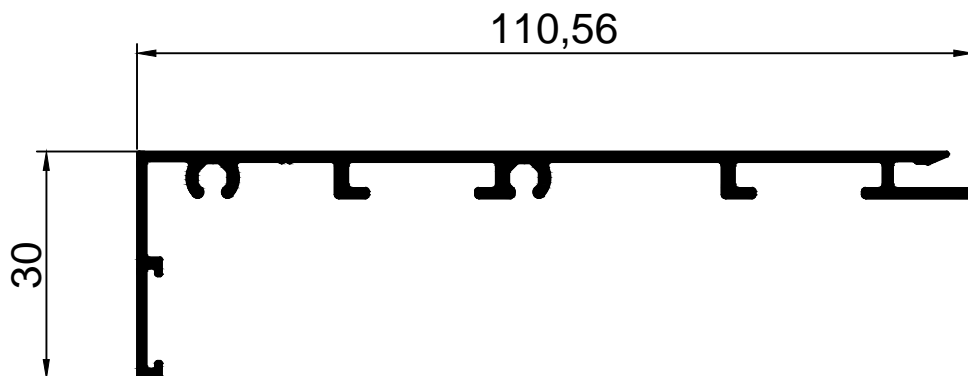

ALAS 01707

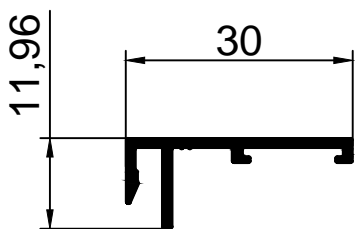

ALAS 01711

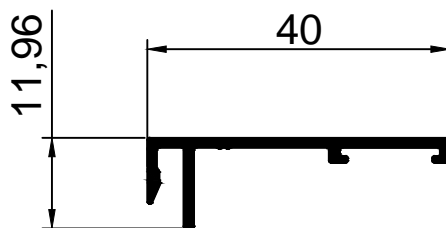

ALAS 1712

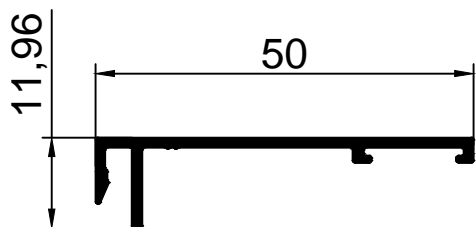

ALAS 01713

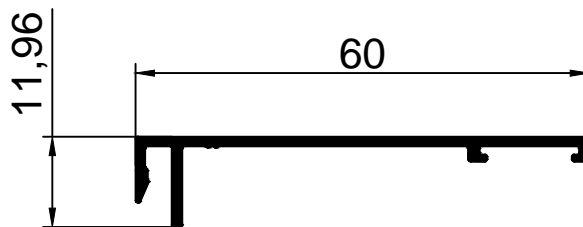

ALAS 1714

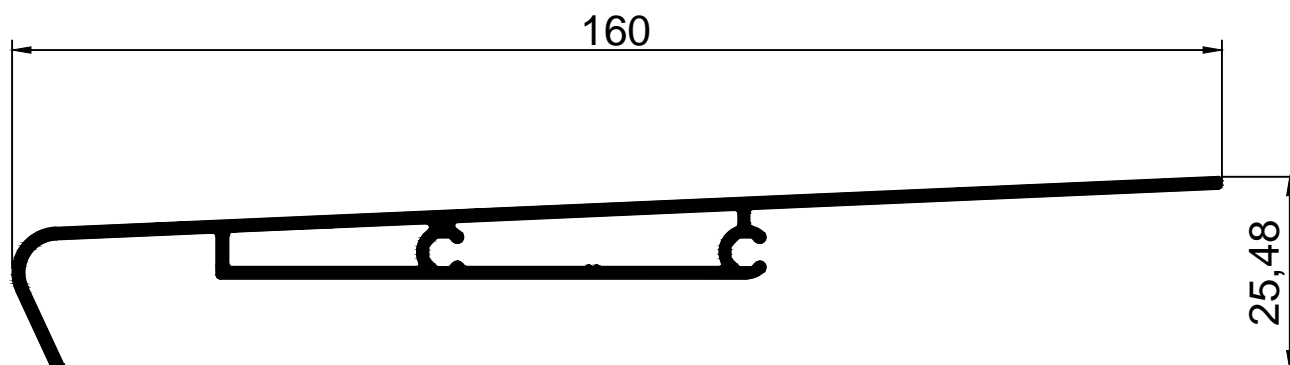

ALAS 01720

**Montajes**

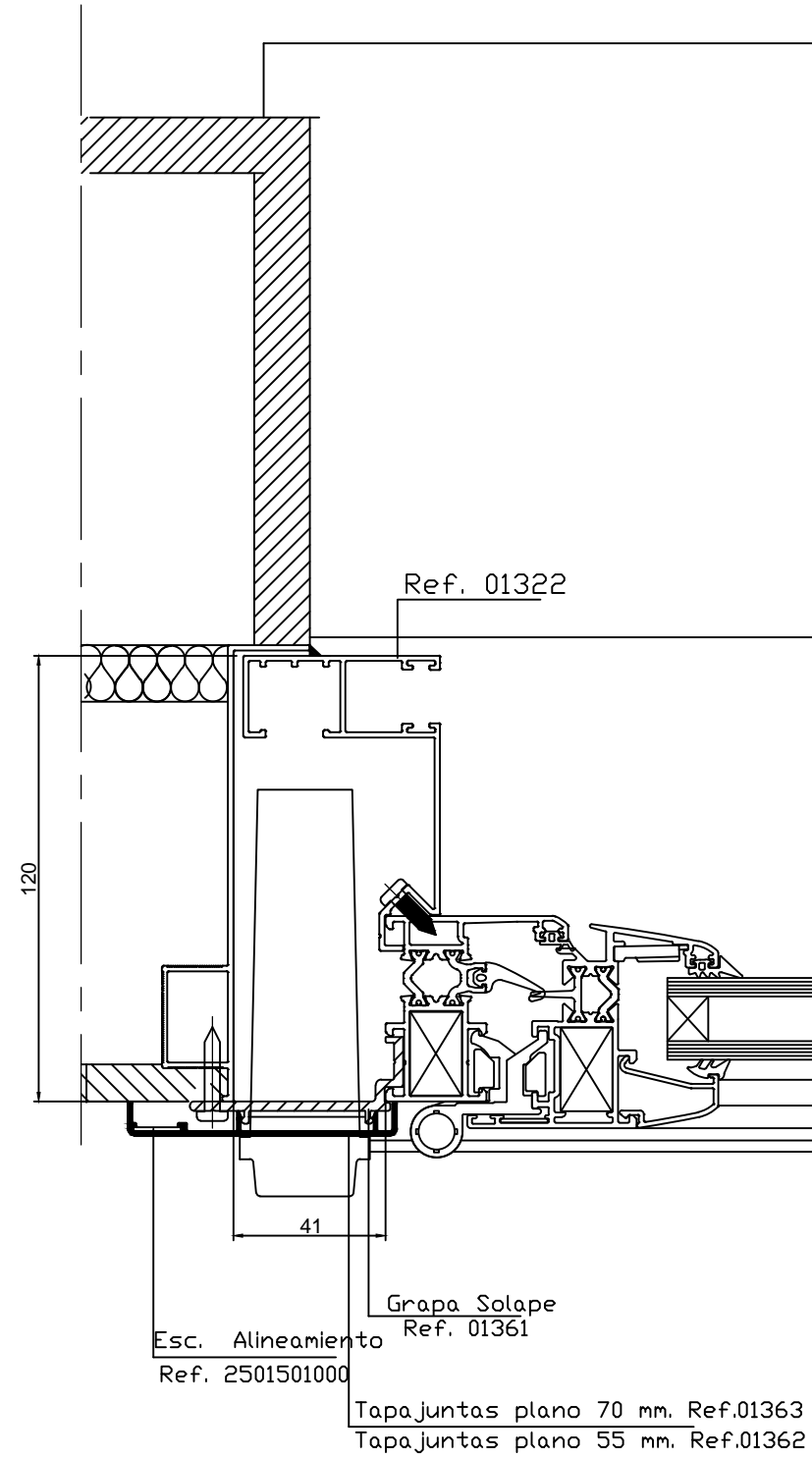

SECCION HORIZONTAL

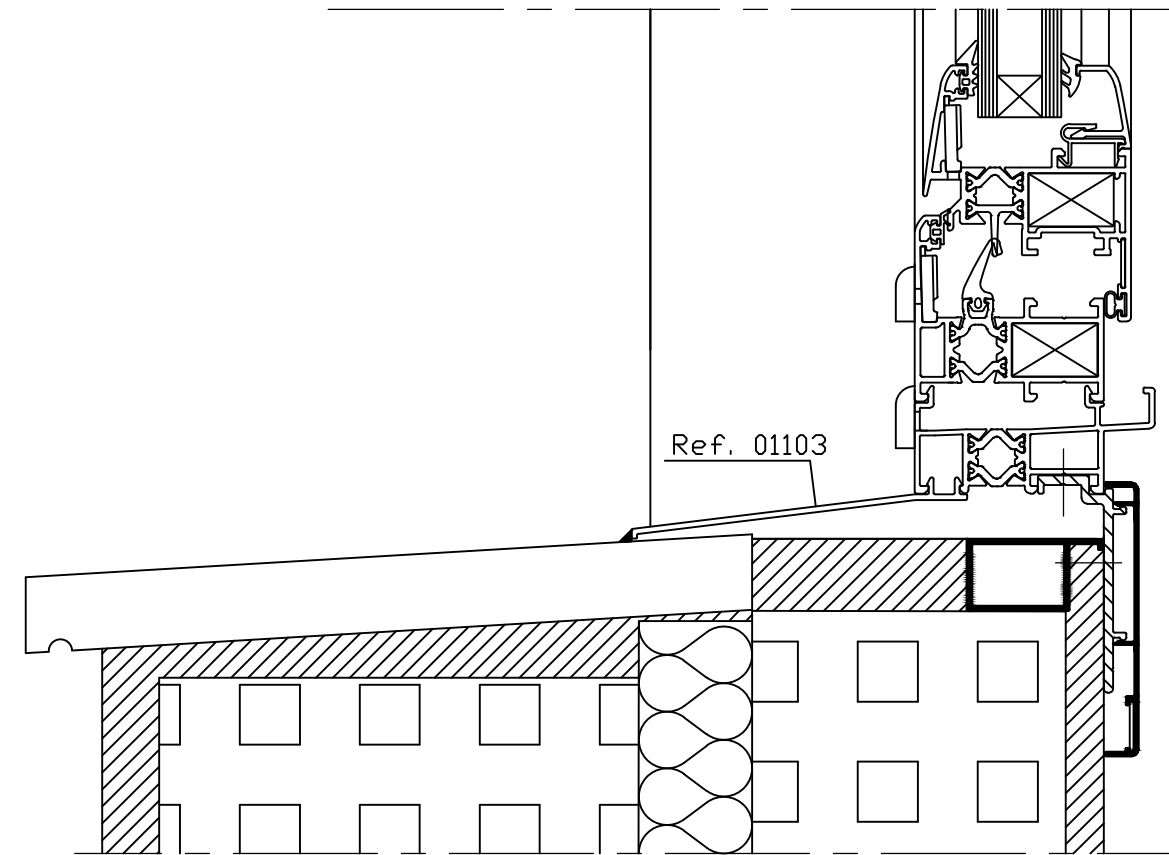

SECCION VERTICAL

Detalle de puesta en obra Escala 1/2

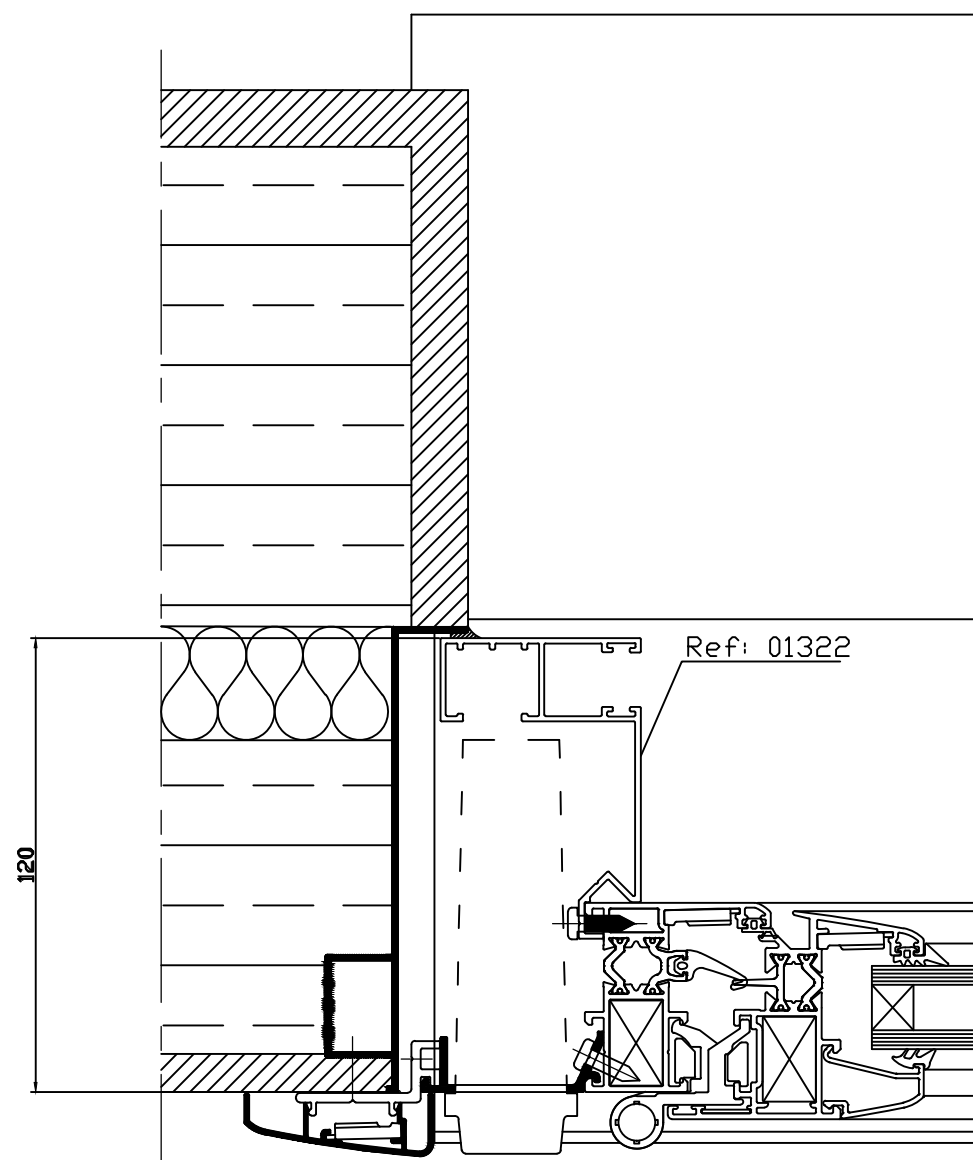

SECCION HORIZONTAL

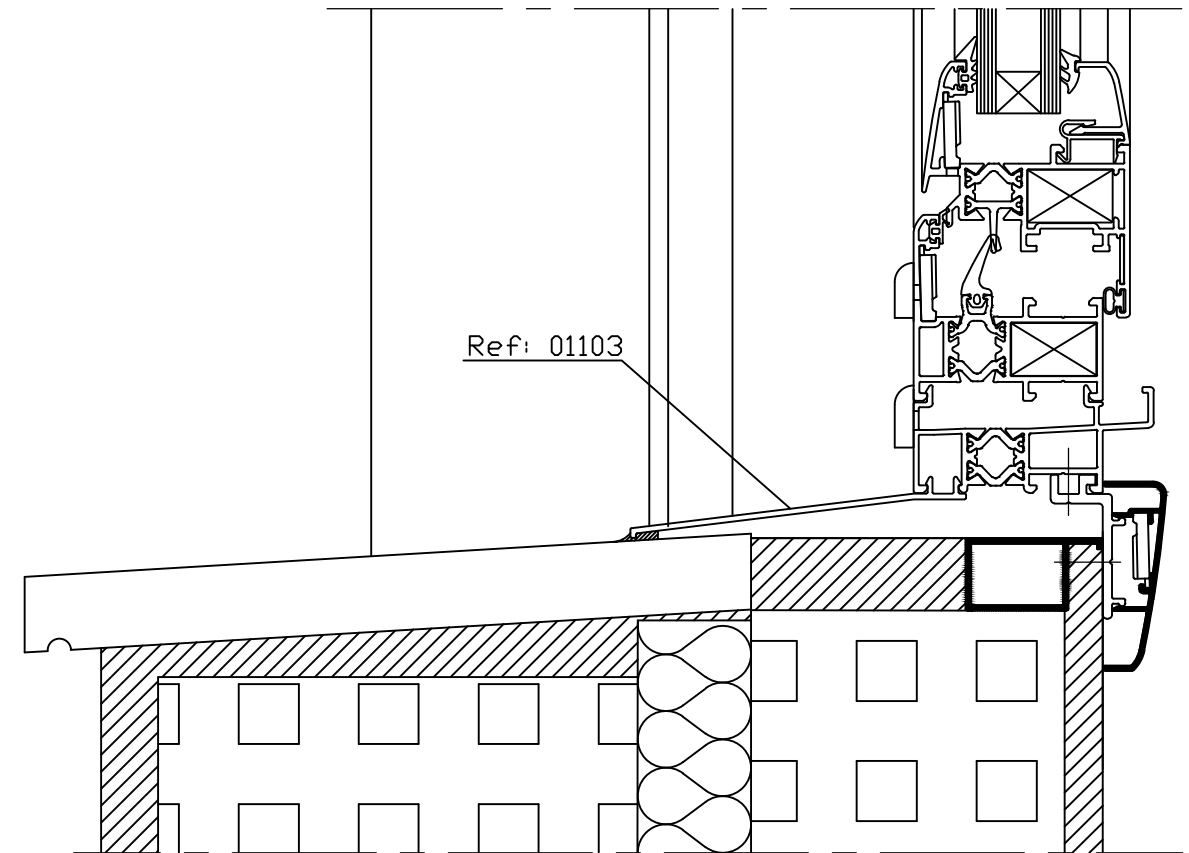

SECCION VERTICAL

Detalle de Puesta en Obra Escala 1/2

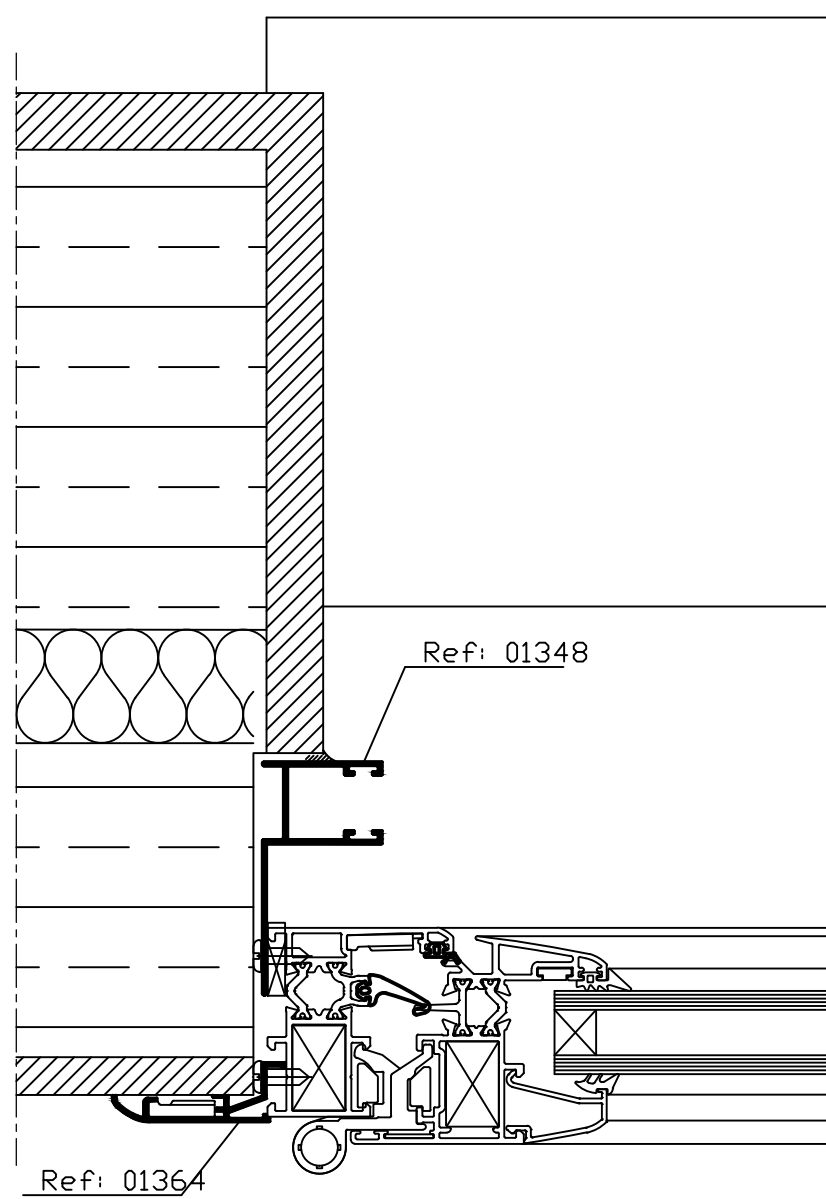

SECCION HORIZONTAL

Detalle de puesta en obra Escala 1/2

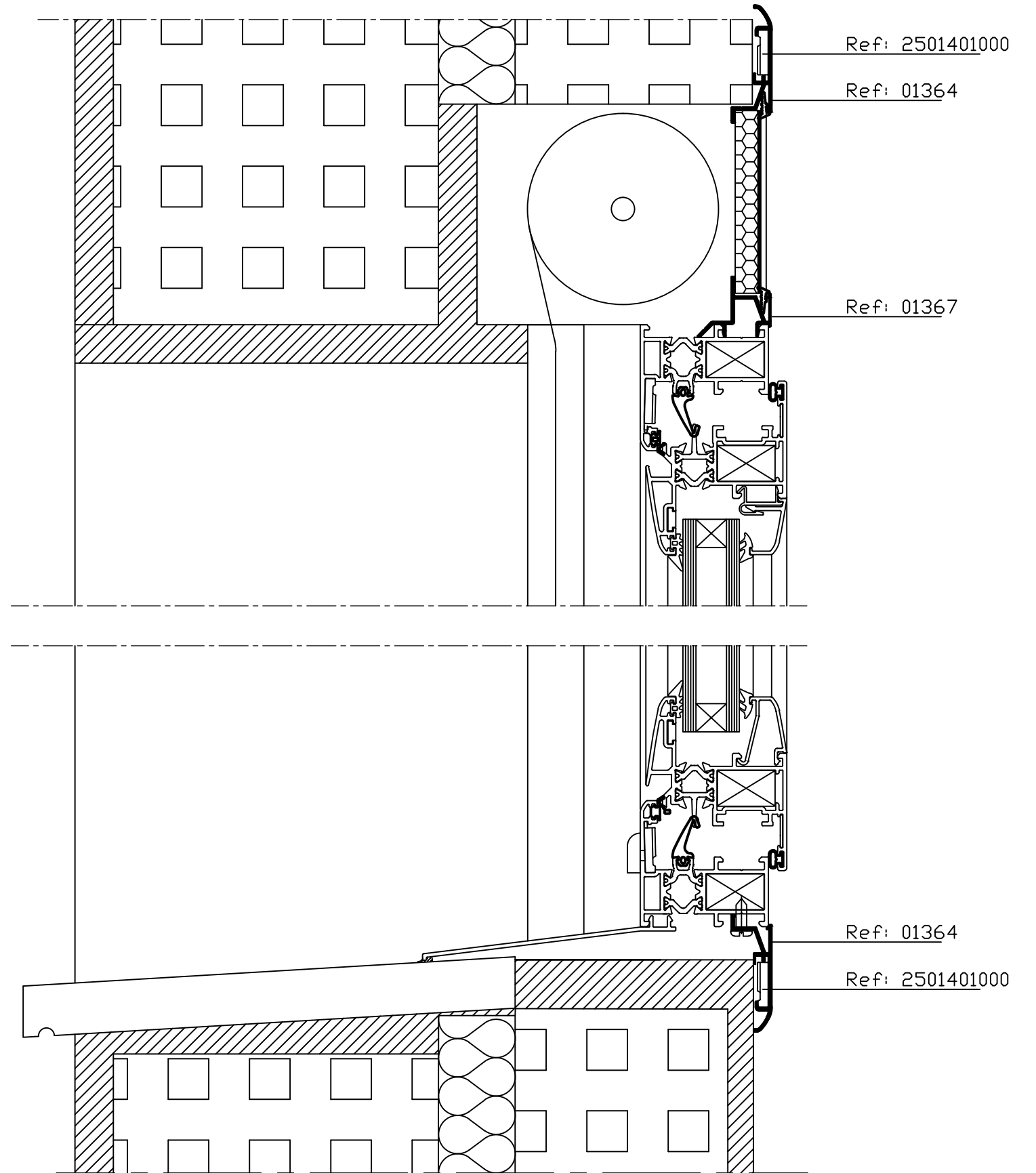

SECCION VERTICAL



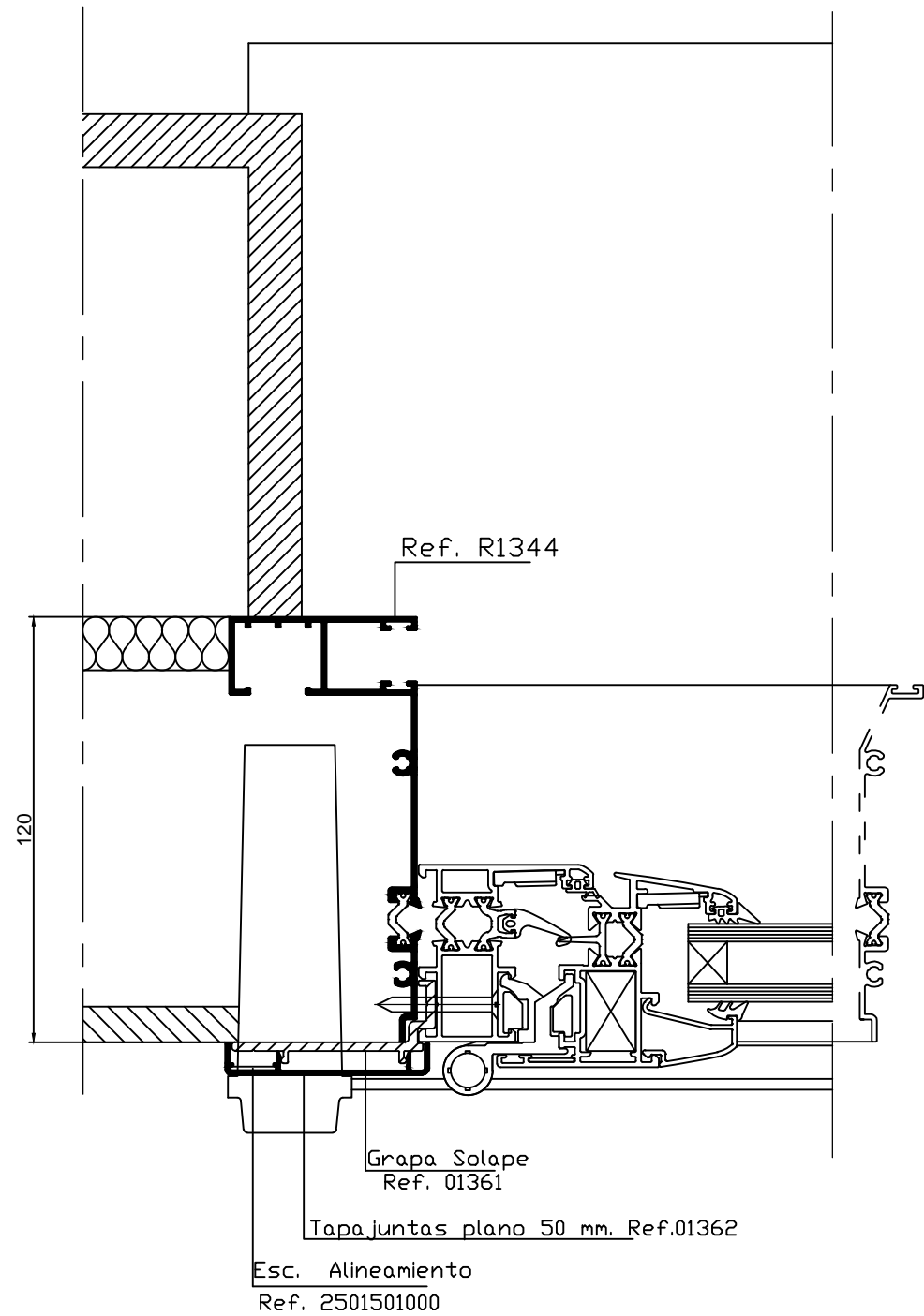

SECCION HORIZONTAL

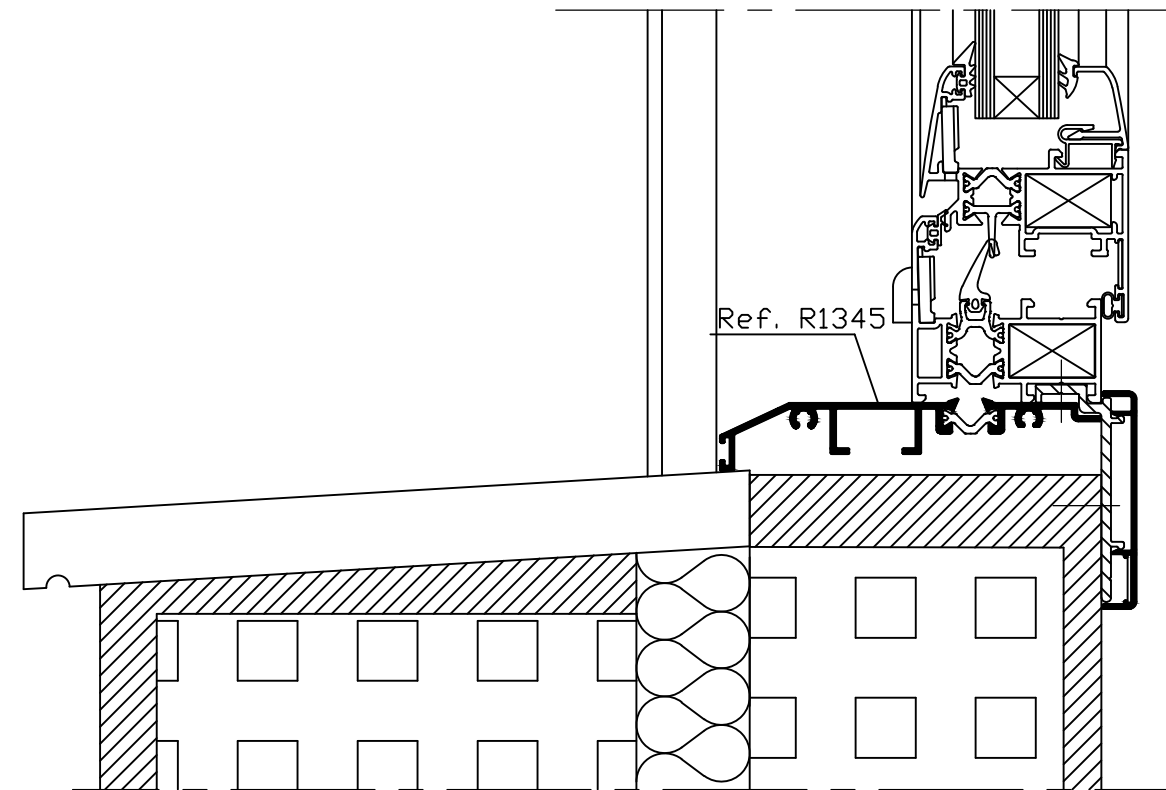

SECCION VERTICAL

Detalle de puesta en obra Escala 1/2

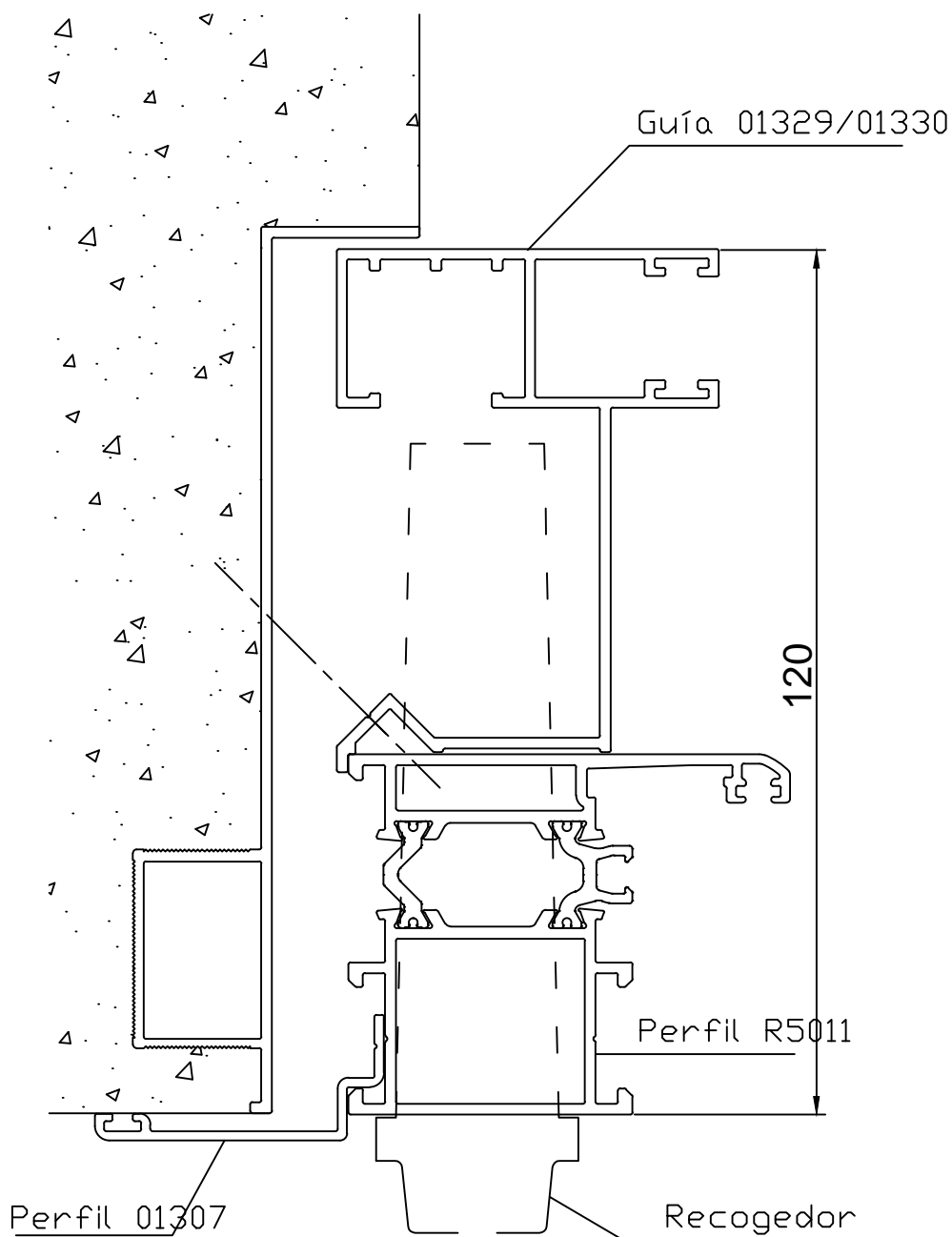

Detalle de puesta en obra Escala 1/1

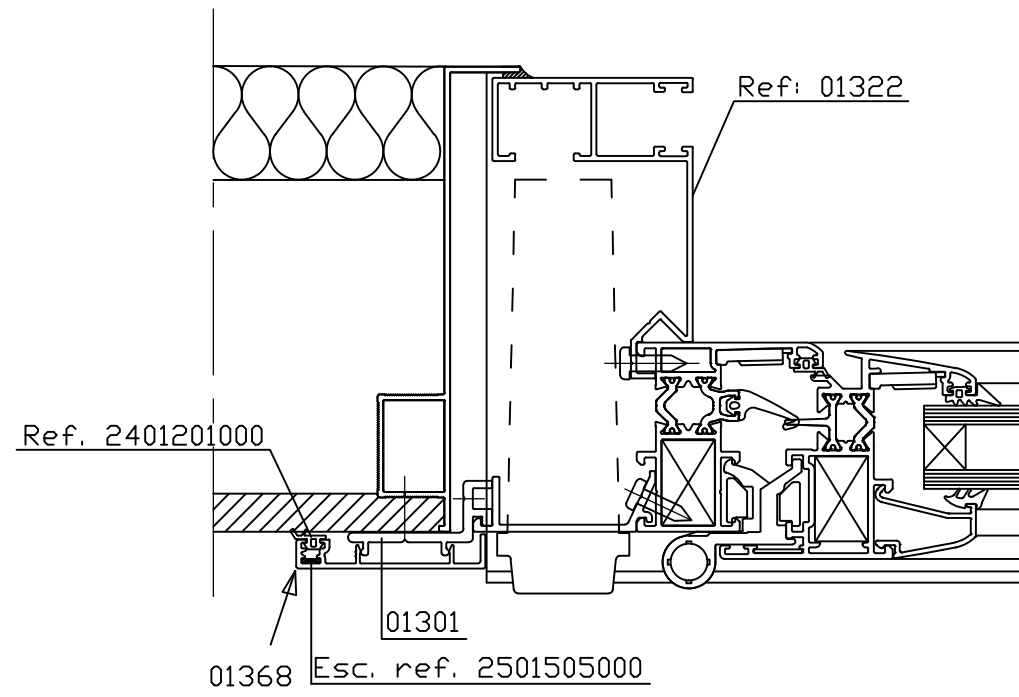

SECCION HORIZONTAL

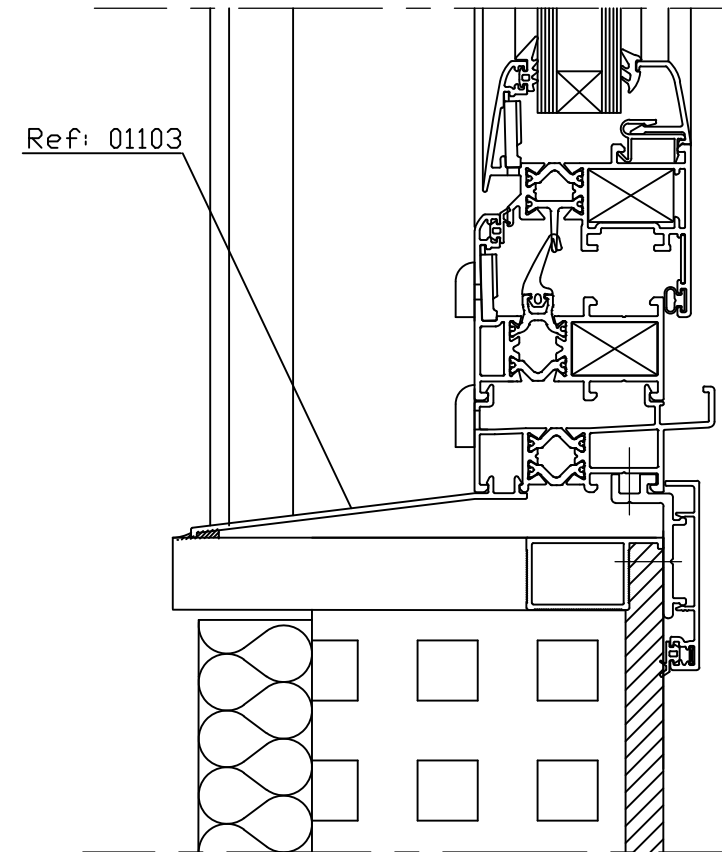

SECCION VERTICAL

Detalle de puesta en obra Escala 1/2

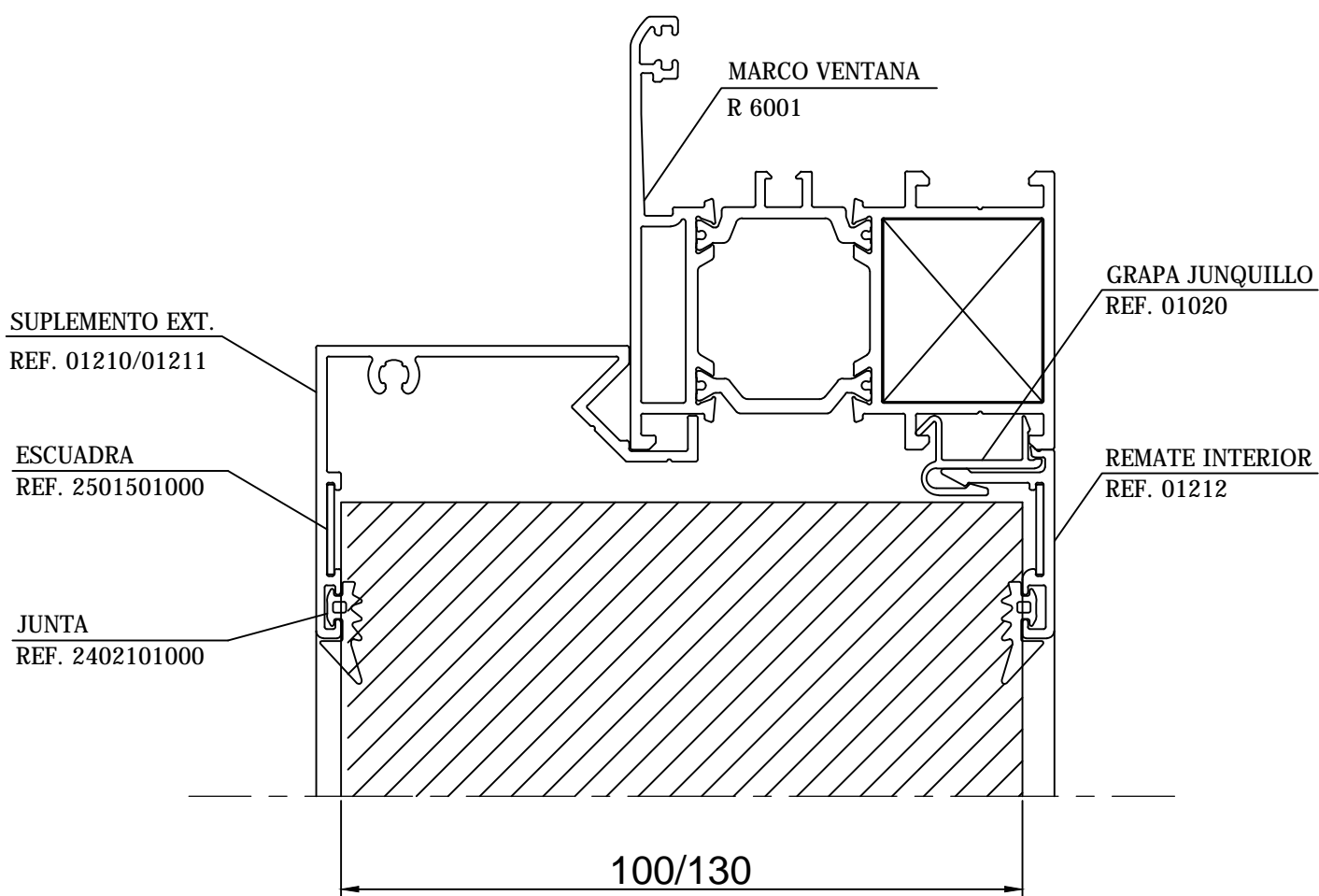

Remate tabique

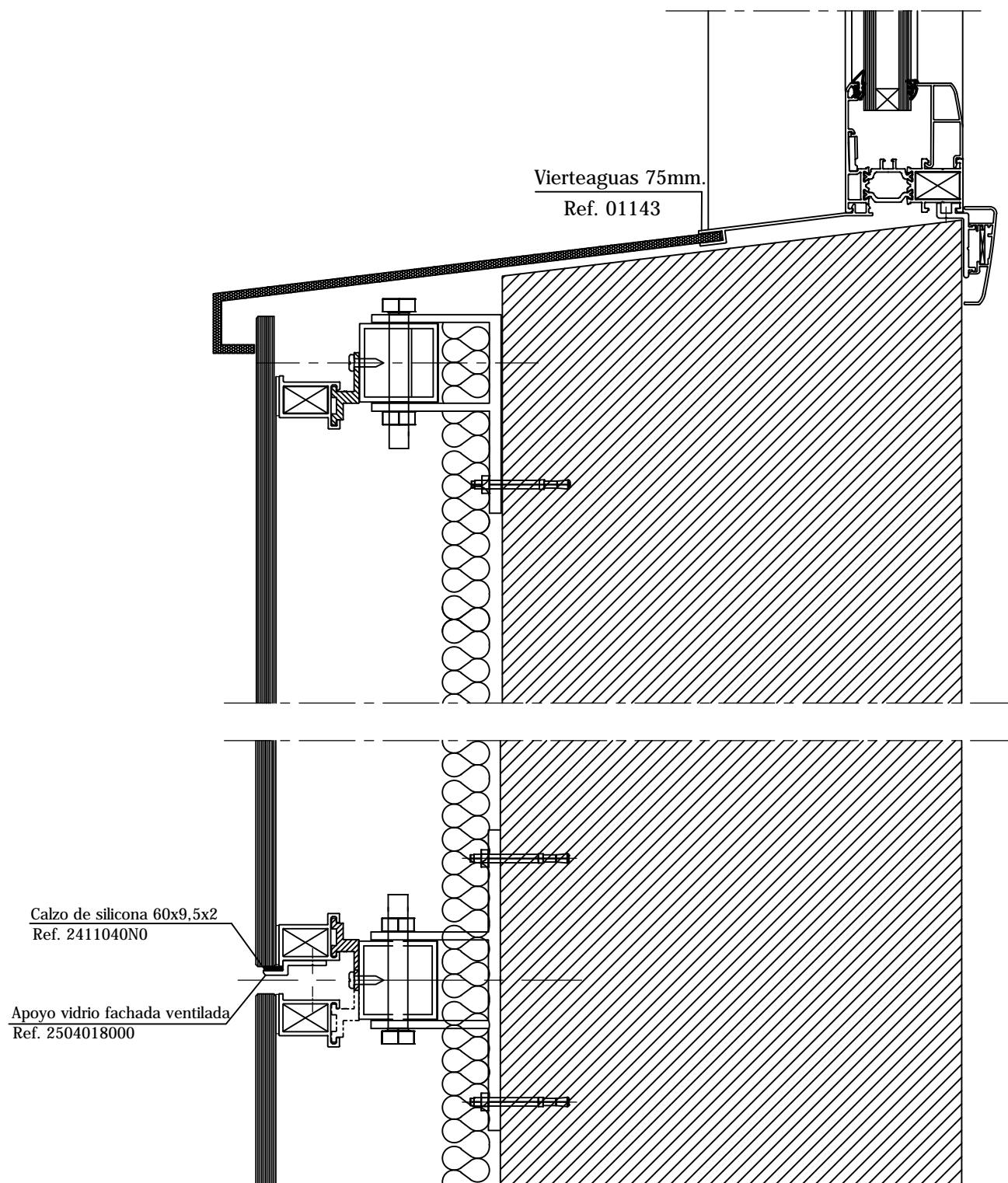

Fachada ventilada acristalada

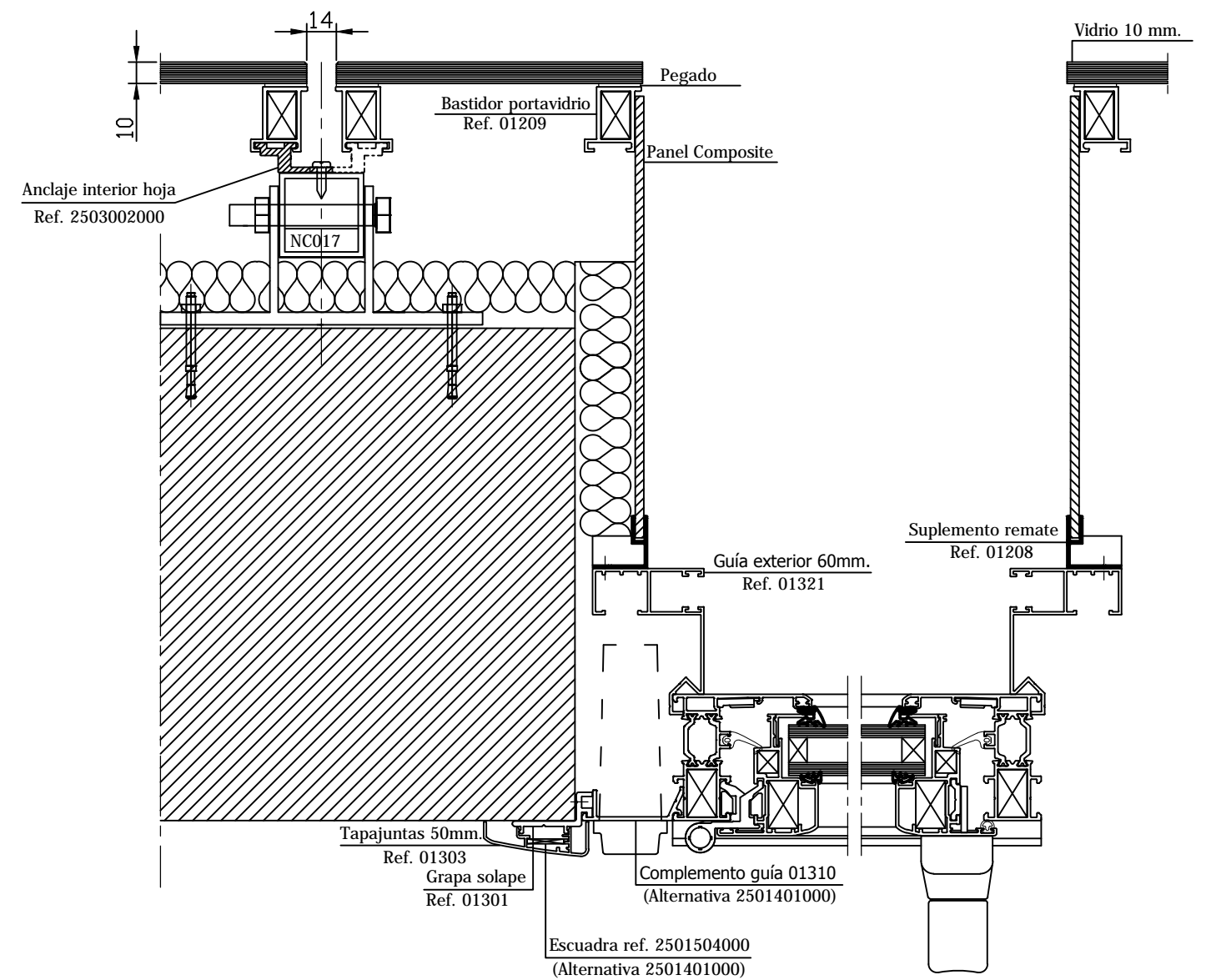

Fachada ventilada acristalada

## AIREADOR SOBRE GUÍA PERSIANA

Cassette aireador de guía  
Ref. 20011040\*0

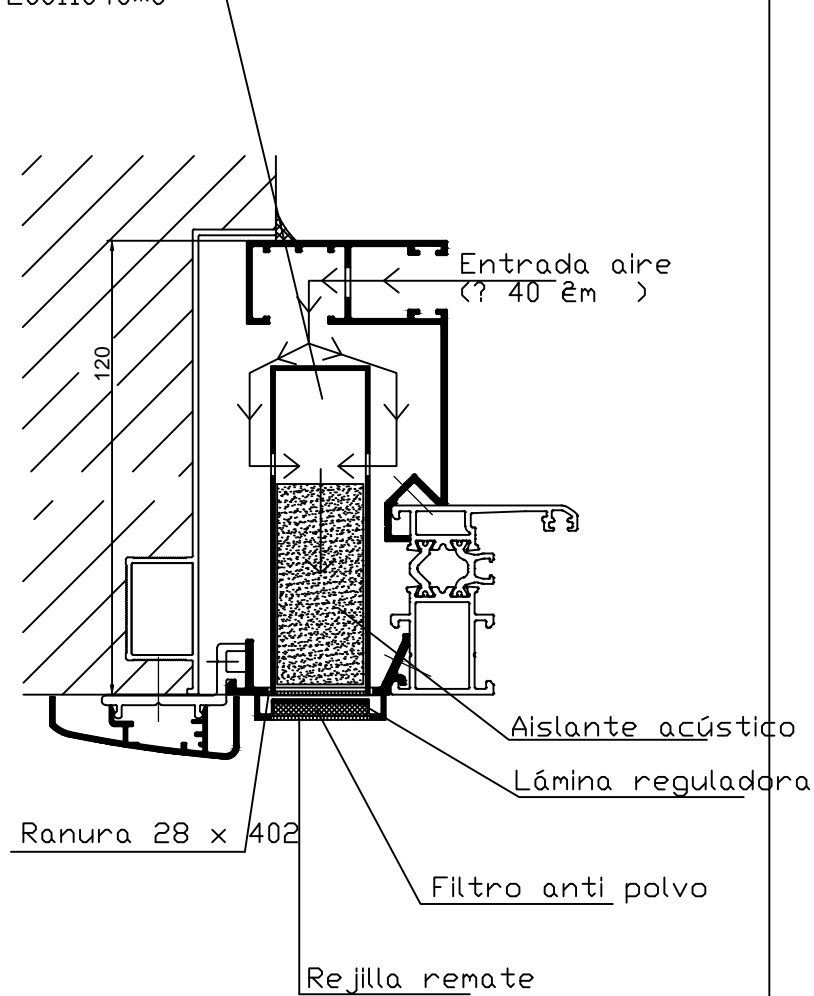

## AIREADOR SOBRE CAJÓN PERSIANA

2 Ranuras sobre tapa cajón 12 x 172

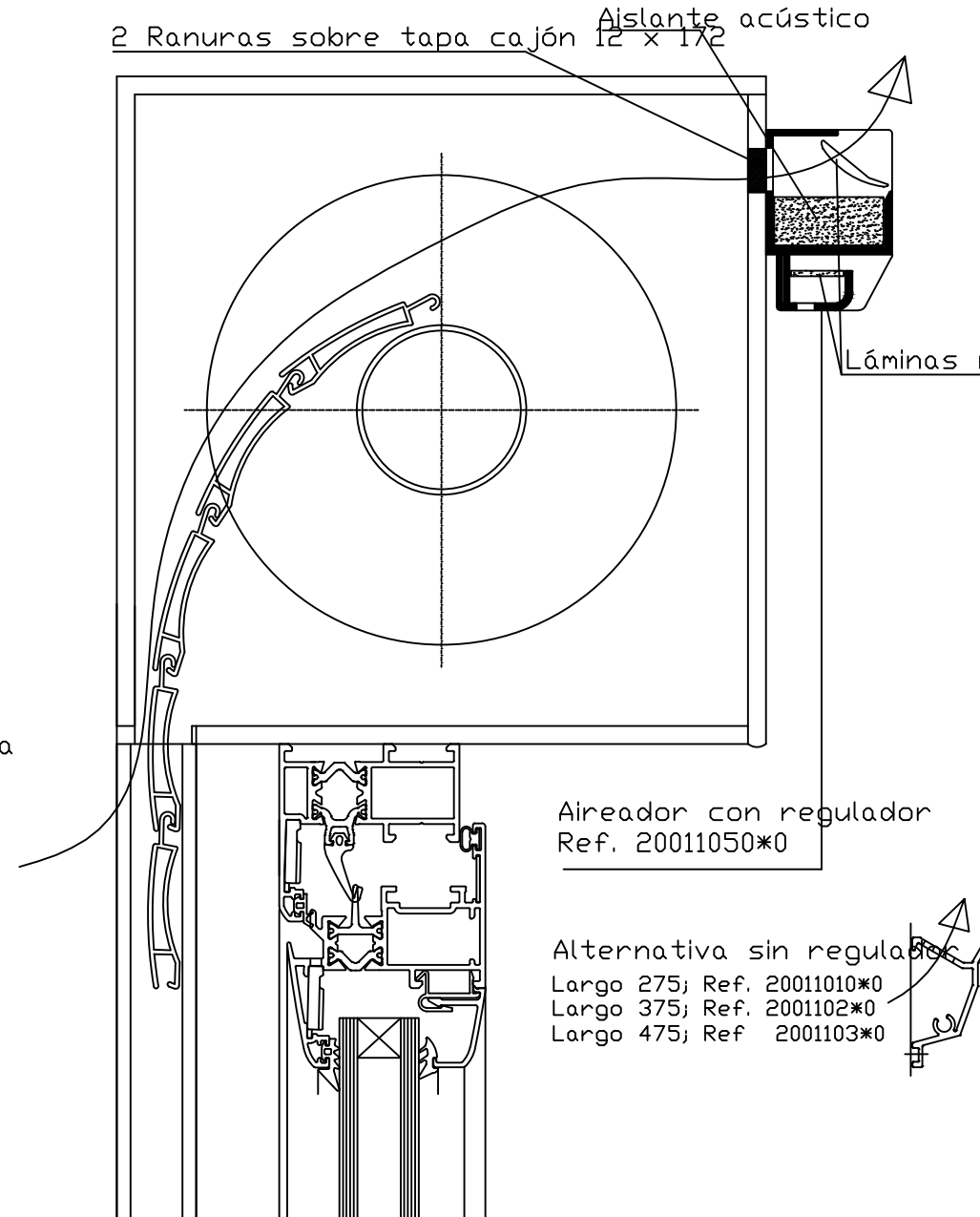

## AIREADOR SOBRE MARCO

Ranuras sobre perfil  
2 grupos de 12 x 172

Conjunto aireador  
marco + rejilla  
Ref. 20011060\*0

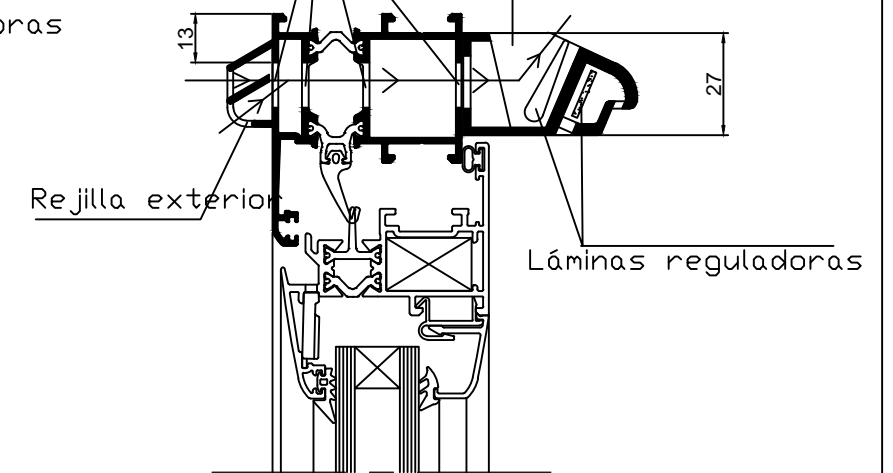



**ALAS**  
**IBERIA** aluminium

**ALAS**  
**IBERIA** aluminium

Avda. Laviana S/N  
33900 – Ciaño – Langreo  
(Asturias) ESPAÑA  
Tf. (+34) 985 989 600  
Fax (+34) 985 989 601  
e-mail: [info@alasisberia.com](mailto:info@alasisberia.com)

Su distribuidor más próximo:

